





IMAGE DISPLAY

SIGNS - PRINTING - EXHIBITION DISPLAYS - PROMO ITEMS

www.imagedisplay.co.uk - sales@imagedisplay.co.uk

DISPLAY

SOLUTIONS HANDBOOK

-  Banners
-  Outdoor Signage
-  Exhibition & Portable Marketing Kits
-  Pop-ups & Hop-ups
-  Literature Holders
-  Tablet Holders, Graphic Pods & Lightboxes
-  Accessories

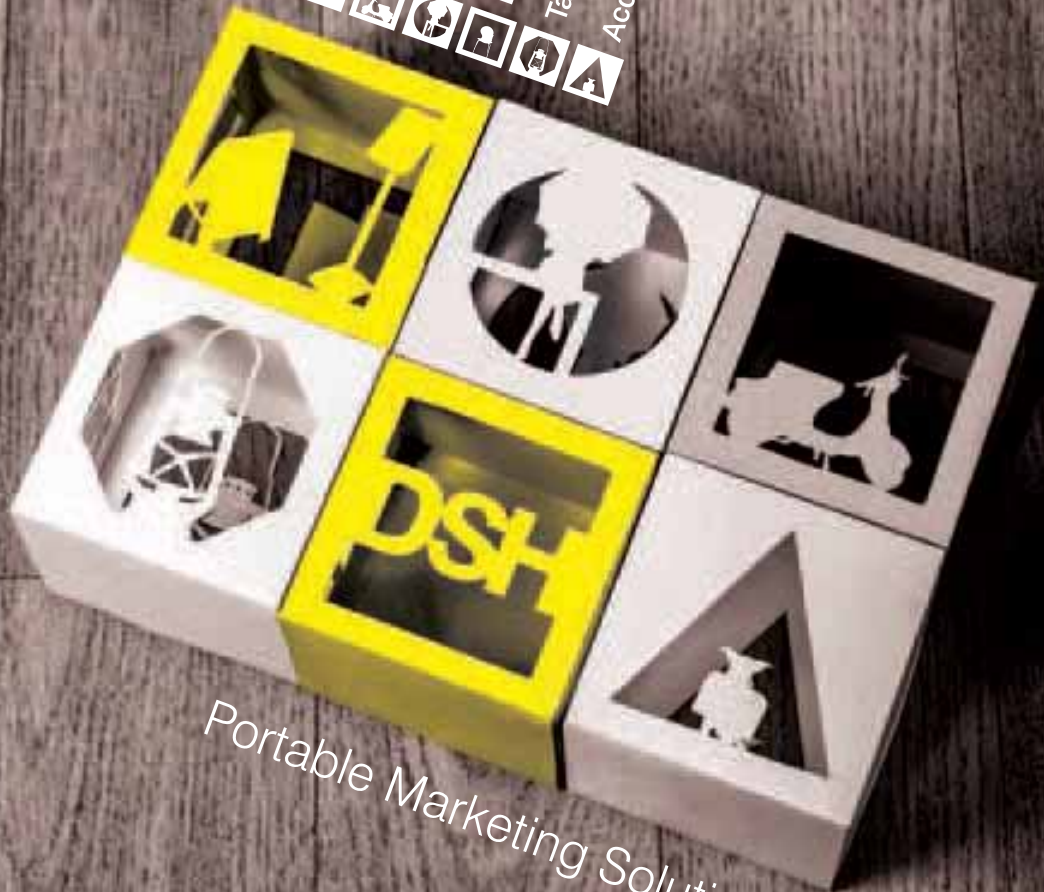

Portable Marketing Solutions



The Display Solutions Handbook is a handy brochure with all the information you need when choosing portable display products.

Each item has details to help you decide if it's the right product for the job. There is also an indepth section on modular display solutions with expert advice on different types of stands, the materials used and how to get the most out of your stand.

Banners	2	Literature Holders	68
Outdoor/Indoor	24	Portable Counters	72
Basics	38	Signage Systems	80
Pop-ups & Hop-ups	44	Tablet Holders, Graphic Pods and Lightboxes	88
Exhibition & Portable Marketing Kits	52	Accessories	92
Panel Kits	62		



Take a look at the QR code to find out more about our product videos on selected items.



Symbols used in the Display Solution Handbook



We're always looking for fresh ways to keep our customers interested.



Keep an eye out for the Augmented Reality (AR) logo and by using our AR app on your smart phone or tablet you will be able to see our products in a new and exciting way!



Using the latest CAD software technology, our experienced 3D design team will work with you to design and then render your exhibition display stand so you can view before you buy.



Economy product



Standard product



Premium product



Product comes with case or bag



New product



Large format product



Product can be recycled



Augmented Reality



Product designed in UK/EU



Product made in UK/EU



One year warranty



Five year warranty



Life time warranty

All hardware and graphic sizes are approximate and to be treated as a guide only. Please request full graphic template for printing purposes.



BANNERS

Impact, Display, Durable

Whatever your requirements there is a banner to fit.

With the widest range to suit all budgets, banners are still one of the most effective ways to promote your business. Most of our banners come complete with a carry bag for safe transportation.

If you need to remove and replace your graphic regularly and require a reliable, quality banner, a cassette banner is a suitable cost effective solution to consider.



Imagine cassette roller banner is packed with features designed to make it quick and easy to use.

Imagine

800mm (wide) UB502C-800A2

1000mm (wide) UB502C-1000A2

- Standard graphic height (approx) 2130mm
- Cassette banner
- Quick change graphics
- Adjustable feet and integral telescopic pole storage
- Will support leaflet holder or shelf

Total hardware dimensions (approx):
855-2210 (h) x 870/1070 (w) x 220 (d) mm



*Stylish,
tough
end cap*

Replacement cassettes
UB500C-800A



Stylish and easy to use cassette banner



Quick change graphics cassette



Ratchet graphic tensioner

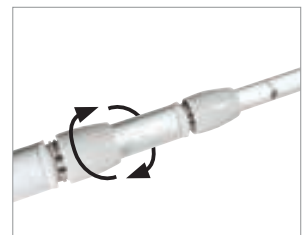

Telescopic pole



Polycarbonate changeable end caps

Cassette Banners

If you need to remove and replace your graphic regularly and require a reliable, quality banner, a cassette banner is a suitable cost effective solution to consider.



Merlin



- 850mm (wide) UB160-850
- 1000mm (wide) UB160-1000

- Standard graphic height (approx) 2000mm
- Value cassette banner
- Quick change graphics
- Bungee pole and snap rail

Total hardware dimensions (approx):
2110 (h) x 880/1030 (w) x 190 (d) mm



Osprey



- 850mm (wide) UB170-850
- 1000mm (wide) UB170-1000

- Standard graphic height (approx) 2030mm
- Deluxe cassette banner
- Quick change graphics
- Bungee pole, snap rail and adjustable feet

Total hardware dimensions (approx):
2115 (h) x 895/1045 (w) x 220 (d) mm



Cassette cartridges

Cassette banners have an advantage as their graphic cartridge is housed independently from the main base unit.

This means you can change your graphic as often as you need simply and easily yourself.

There is no need to return or replace your banner to have new graphics fitted, simply remove and replace the cartridge for an instant graphic change.

Keep a selection of cartridges at hand to change your message as required, which allows for fast moving promotions.



Spare cassette codes for either Merlin or Osprey

UB175-850
UB175-1000

A roller banner is the most popular, light-weight and easy to use banner system on the market. There is a roller banner for every occasion and any budget to make your message stand out from the crowd.



The toughest, coolest, stylish banner we make

A very popular, strong and stylish design, proven as a reliable banner for regular use. Ideal for simple displays or exhibitions. Position your graphic to the height required with the adjustable telescopic pole.



Barracuda

- 800mm (wide) WH321C-800A2
- 1000mm (wide) WH321C-1000A2

- Standard graphic height (approx) 2130mm
- Strong and durable design
- Large internal graphic housing with tensioner
- Universal grippa/ adhesive top rail and adjustable telescopic pole
- Quick change slide in leader system

Total hardware dimensions (approx):
840-2200 (h) x 865/1065 (w) x 95 (d) mm

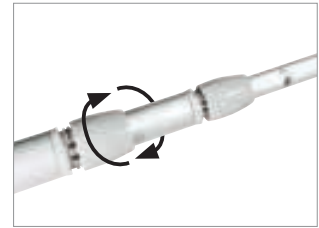

Telescopic pole



End profile in smoked polycarbonate, cleverly hiding the graphic tensioner



Adjustable feet



Clever telescopic pole storage



Adjustable height from 840-2200mm

Excaliber 1 & 2

- 800mm (wide)** S: WH301C-800A2
D: WH311C-800A2
- 1000mm (wide)** S: WH301C-1000A2
D: WH311C-1000A2

S: Single sided / D: Double sided

- Standard graphic height (approx) 2130mm
- Single or double sided, wide base premium banner
- Ratchet graphic re-tensioner and telescopic pole
- Adjustable feet and universal rail
- Quick change slide in leader system

Total hardware dimensions (approx):
860-2215 (h) x 870/1070 (w) x 270(d) mm



Original Banner 2

- 600mm (wide)** Silver: UB322-600A
Black: UB322-600B
- 800mm (wide)** Silver: UB322-800A
Black: UB322-800B
- 1000mm (wide)** Silver: UB322-1000A
Black: UB322-1000B

Also available in grand format sizes up to 2400mm wide.
For more details see page 21.

- Standard graphic height (approx) 2145mm
- Adjustable feet with hard wearing end plates
- Quick-change external slide in leader system
- Universal rail
- Wide range of widths available for use with Linear accessories

Total hardware dimensions (approx):
2240 (h) x 830/880/950/1030 (w) x 195 (d) mm



Watch video



Original Banner 3

- 600mm (wide)** Silver - S: UB302-600A / D: UB312-600A
Black - S: UB302-600B / D: UB312-600B
- 800mm (wide)** Silver - S: UB302-800A / D: UB312-800A
Black - S: UB302-800B / D: UB312-800B
- 1000mm (wide)** Silver - S: UB302-1000A / D: UB312-1000A
Black - S: UB302-1000B / D: UB312-1000B

S: Single sided / D: Double sided

Also available in grand format sizes up to 2400mm wide.
For more details see page 21.

- Standard graphic height (approx) 2145mm
- Single or double sided, wide base
- Adjustable feet with super tough end plates
- Quick-change external slide in leader system
- Universal rail

Total hardware dimensions (approx):
2240 (h) x 830/880/950/1030 (w) x 195 (d) mm



Watch video



Available in widths up to 2400mm



A variety of banners come in large format sizes. Look out for this symbol.
For more details see page 21.



Roller Banners

A roller banner is the most popular, light-weight and easy to use banner system on the market. There is a roller banner for every occasion and any budget to make your message stand out from the crowd.



Premium Banners / Roller

Choose any of our premium banners with top Linear channel and suspend an extra graphic between both roller banners.

NEW

Increase your graphic area with a cost effective linking banner kit.



Premium banner linking kits

- Create a montage effect and increase the size of your display area at minimal cost.
- Banners can be positioned in a straight line or curved to enhance your look
- Kit comes complete with a carry bag.
- No tools required

Available to use with our premium banner range Original, Imagine, Excaliber, Barracuda

Please advise linking kit requirements at time of order

Premium banner accessories

Premium Banner Linear Accessories are a great way to enhance your banner with a choice of optional extras including a shelf, literature holder or a TV monitor bracket.

These Linear accessory kits are available on our premium banner range Original, Imagine, Excaliber, Barracuda and fit smoothly into the Linear channel.

iPad holder available. Contact us for details.

Option C
LCD mount - LNBA-03



Original 3 with optional Linear accessories

TV monitor not included

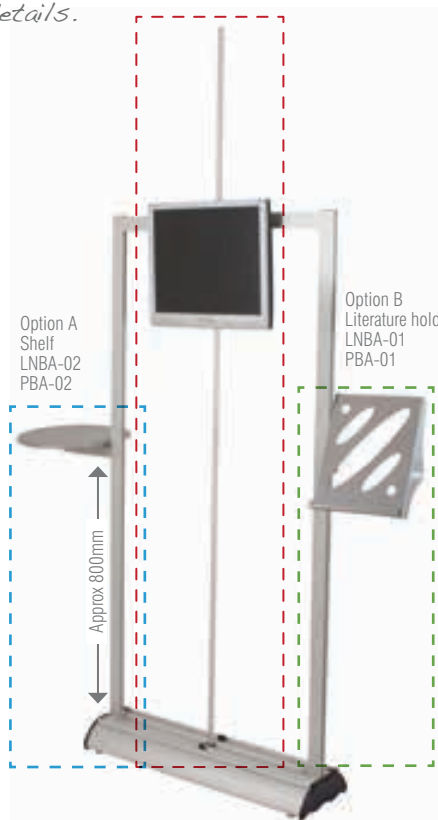

Literature holder PBA-01



Shelf PBA-02

Linear accessories available on premium banners as advised above:
Option A - Shelf
Option B - Literature holder
Option C - LCD mount. Available on Original 3 and Excaliber banners only.

Popular stylish roller banner available in a wide range of widths between 800-2000mm.

Orient

800mm (wide) WH353-800-001

1000mm (wide) WH353-1000-001



Also available in grand format sizes up to 2000mm wide. For more details see page 21.

- Standard graphic height (approx) 2110mm
- Graphic pulls up from the front for floor to rail visibility
- Adjustable feet for levelling
- Hybrid pole and snap rail

Total hardware dimensions (approx):
2160 (h) x 830/880 (w) x 185 (d) mm



Watch video

Available in widths up to 2000mm



End profile of base



Adjustable feet for levelling



Front entry graphic

Roller Banners

A roller banner is the most popular, light-weight and easy to use banner system on the market. There is a roller banner for every occasion and any budget to make your message stand out from the crowd.



Orient 2

800mm (wide) WH355-800

1000mm (wide) WH355-1000

- Standard graphic height (approx) 2110mm
- Double sided front loading banner
- Comes complete with two rollers and secure doubler
- Hybrid pole, snap rail and adjustable feet

Total hardware dimensions (approx): 2160 (h) x 830/880 (w) x 185 (d) mm



Arc

NEW

850mm (wide) UB180-850

- Standard graphic height (approx) 2220mm
- Stylish wood veneer base
- Aluminium bungee pole and rail
- Cast metal end plates and pole fittings

Total hardware dimensions (approx): 2260 (h) x 870 (w) x 220 (d) mm



Blade Lite

850mm (wide) UB509-850

1000mm (wide) UB509-1000

- Standard graphic height (approx) 2110mm
- Stylish chrome end plates
- Adjustable feet
- Snap rail
- Will house thicker graphics (up to 400 microns)

Total hardware dimensions (approx): 2170 (h) X 905/1055 (w) x 220 (d) mm

High quality chrome finish end caps



Delta Lite

850mm (wide) UB205-850-001

1000mm (wide) UB205-1000-001

- Standard graphic height (approx) 2000mm
- Adjustable feet
- Snap rail
- Large capacity roller banner

Total hardware dimensions (approx): 2085 (h) x 900/1050 (w) x 200 (d) mm

Stylish chrome finish end caps



Pacific

- 800mm (wide)** WH351-800-01
- 1000mm (wide)** WH351-1000-01

- Standard graphic height (approx) 2150mm
- Slimline anodised silver base, hybrid pole and snap rail
- Adjustable height and twist out foot

Total hardware dimensions (approx):
1550 min / 2210 max (h) x 830 (w) x 370 (d) mm



Eco

- 800mm (wide)** UB198-800
- 1000mm (wide)** UB198-1000

- Standard graphic height (approx) 2010mm
- Quick change snap rail
- Twist out foot
- Anodised silver base with black end-plates

Total hardware dimensions (approx):
2110 (h) x 830/1030 (w) x 445 (d) mm



Start

- 800mm (wide)** UB120-800
- 850mm (wide)** UB120-850
- 1000mm (wide)** UB120-1000

- Standard graphic height (approx) 2025mm
- Graphic pulls up from the front for floor to rail visibility
- Twin twist out feet

Total hardware dimensions (approx):
2070 (h) x 896 (w) x 286 (d) mm



Top five tips | for choosing the right banner

With so many banners to choose from, how do you decide which is the right product for the job?

1. Consider where your banner will be used – indoors or outdoors, occasionally or everyday
2. Select the correct type of material – e.g. banner vinyl, mesh or textile fabric
3. How quickly do you need to change and replace graphics? If often consider a cassette banner option, if not a roller banner is the ideal solution
4. What is your budget? Choose from economy if use is a one off or short promotion, right up to premium for when a quality product is required for extended use
5. Size matters! Banners come in a wide range of heights and widths. Consider the environment and space available, banners should gain the interest of your customer, but not get in their way

Roller Banners

A roller banner is the most popular, light-weight and easy to use banner system on the market. There is a roller banner for every occasion and any budget to make your message stand out from the crowd.



ONE YEAR

If it's high impact you are after, then the Giant Mosquito is the banner for the job. At three meters high you can be sure this banner will be seen by all.

NEW

Available in grand format
2000mm wide,
3000mm high

Giant Mosquito

850mm (wide) UB300-850

1000mm (wide) UB300-1000



Also available in grand format sizes up to 2000mm wide. For more details see page 23.

- Standard graphic height (approx) 3000mm
- One of the largest economy banners you can buy
- Hybrid pole can be set at various heights up to 3m
- Twin twist out feet and snap rail

Total hardware dimensions (approx):
3100mm (h) x 869/1019mm (w) x 400mm (d)



Max height (approx) 3100mm



End profile



Hybrid pole



Twin twist out feet



Back profile

Mosquito

- 600mm (wide)** UB197-600
- 800mm (wide)** UB197
- 850mm (wide)** UB196
- 1000mm (wide)** UB197-1000



Also available in grand format sizes up to 2000mm wide. For more details see page 23.

- Standard graphic height (approx) 1992mm
- Available in seven different widths 600/800/850/1000/1200/1500/2000mm
- Quality snap rail
- Twin twist out feet

Total hardware dimensions (approx):
2105 (h) x 860 (w) x 285 (d) mm
Based on 850mm banner



Watch video

Available in widths up to 2000mm



Mini Mosquito



- 600mm (wide)** UB197-600-01

Ideal for retail applications

- Standard graphic height (approx) 1600mm
- Quality snap rail with twist out foot
- Anodised silver finish

Total hardware dimensions (approx):
1615 (h) x 600 (w) mm



Grasshopper

- 800mm (wide)** UB191
- 850mm (wide)** UB193
- 1000mm (wide)** UB191-1000



Also available in grand format sizes up to 1500mm wide. For more details see page 23.

- Standard graphic height (approx) 2000mm
- Twin twist out feet
- Self adhesive graphic fixing
- Available 800/850/1000/1200/1500mm widths

Total hardware dimensions (approx):
2098 (h) x 860 (w) x 285 (d) mm
Based on 850mm banner.



Available in widths up to 1500mm

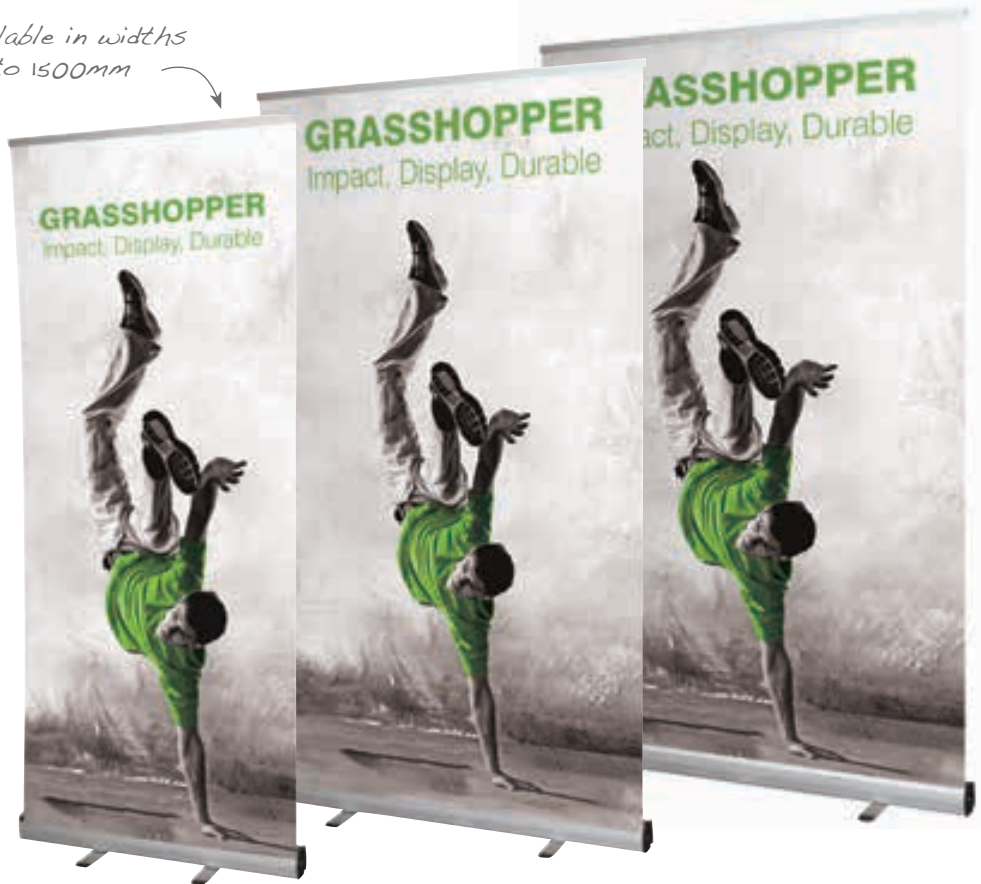

Roller Banners

A roller banner is the most popular, light-weight and easy to use banner system on the market. There is a roller banner for every occasion and any budget to make your message stand out from the crowd.



Mayfly

800mm (wide) UB210-800

850mm (wide) UB210-850

- Standard graphic height (approx) 2000mm
- Twin twist out feet
- Self adhesive graphic fixing
- Bungee pole

Total hardware dimensions (approx): 2090 (h) x 816/866 (w) x 350 (d) mm

Self adhesive



Firefly

800mm (wide) UB206-800

850mm (wide) UB206-850

1000mm (wide) UB206-1000

- Standard graphic height (approx) 2000mm
- Twin twist out feet
- Snap rail and bungee pole

Total hardware dimensions (approx): 2090 (h) x 816/866/1016 (w) x 350 (d) mm

Snap rail



Wasp

800mm (wide) UB204-800-03

850mm (wide) UB204-850-03

1000mm (wide) UB204-1000-03

- Standard graphic height (approx) 2000mm
- Twin twist out feet
- Snap rail
- Simple and effective

Total hardware dimensions (approx): 2080mm (h) x 815/865/1015mm (w) x 320mm (d)

Our lowest cost roller banner



Dragonfly

850mm (wide) UB199-850-01

1000mm (wide) UB199-1000-01

- Standard graphic height (approx) 2000mm
- Double sided banner but can be used as single sided
- Snap rail
- Twist out foot

Total hardware dimensions (approx): 2120mm (h) x 865mm (w) x 380mm (d)

Double sided



Modular Roller Banners

Modular roller banners are configurable banners that can be linked to one another to form larger displays, they can also be set at various heights depending on your message or size of area.



Aero (Modular)

- 1000mm (wide) UB213-1000
- 1500mm (wide) UB213-1500
- 2000mm (wide) UB213-2000

- Adjustable graphic heights 1010mm/1510mm/2010mm
- Linkable and reconfigurable roller banner system
- Multiple positions to suit area, add sections as required

Total hardware dimensions* (approx):
 2120 (h) (max) x 4430 (w) x 405 (d) mm
 2120 (h) (max) x 2065 (w) x 1565 (d) mm
 *depends on configuration



Tension Banners

A popular and cost effective banner solution but different to roller banners as the cassette mechanism is external to the stand allowing for quick and easy change over of graphic.

Stealth

UB106

Modular, linkable banner system. Create seamless graphic back walls, link single or double sided units and position at different angles for extra impact.



Watch video

Easy magnetic linking panels



Stealth Accessories

UB106

Add to your Stealth banner display with a range of stylish accessories to include shelf, and literature holder, LCD bracket plus sturdy case that can be transformed into a counter with wrap.



AC433

Optional case suitable for storing two Stealth units, a flexible joining panel and case wrap graphic.

Folding Table Top - C0332



Transport case, available options include case wrap and folding table top



1. LCD Bracket - UB106-SMK1
LCD bracket is a specific design for use on the Stealth. 22" screen max.



2. Literature Holder - LNST-001
Easily fixed to your stand to advertise promotional material.



3. Table top - LNST-002
Attach a table top to the side of your banner.



4. iPad holder also available. Ideal for placing centrally on graphic panel.



Twist & Lock Pole



Each banner pole top includes a unique sprung graphic fixing unit that features an automatic tensioning system to ensure your graphics are held taut.

The unit has two sprung sections that work independently for individual tensioning of double-sided graphics.



Each top graphic fixing also takes up to two universal spotlight fittings to accommodate single or double-sided lighting.

Recommended light - PS250

Just a few ideas for inspiration, see how flexible Stealth is. Use single or double sided graphics so your message can be seen from all angles.



Flexible panels
Panels can curve to different angles



Free-standing island displays
and information units.



Portable road show displays or
demonstrator back walls.



Banner to banner fixing for robust, perfectly straight back walls for events and exhibitions.



Create free-standing exhibition booths and sides.
Large area backdrops for events and sponsorship.



Your image doesn't need to be flat.
Create eye catching curved displays.

Stealth Extension Kit 700/250mm

For use with your existing Stealth banner or as an accessory to a new one. Tool free, simple twist and lock mechanism. Each kit includes pole and two flexible mag bars for side-by-side panel joining.

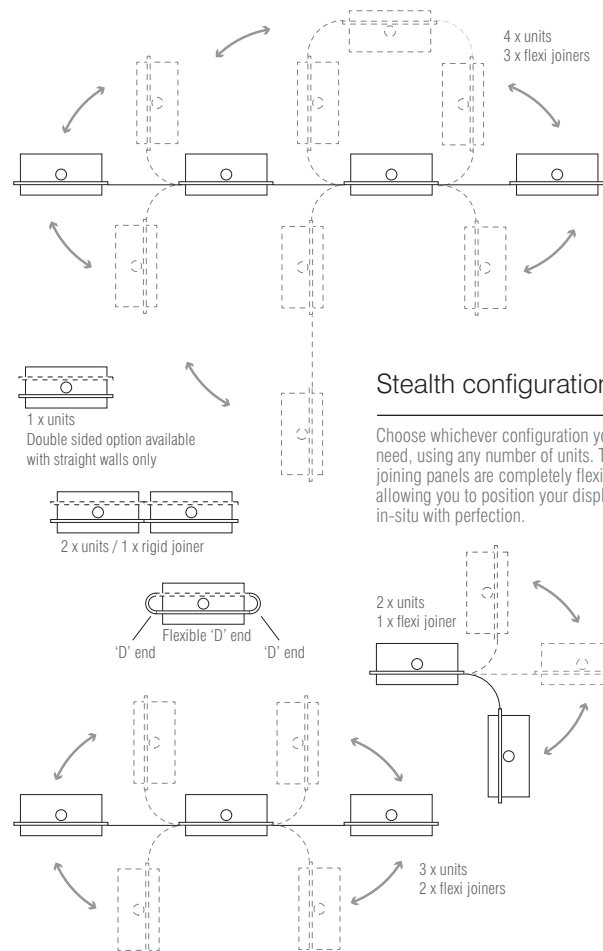

Stealth configurations

Choose whichever configuration you need, using any number of units. The joining panels are completely flexible, allowing you to position your display in-situ with perfection.



Pegasus

1500 - 2410mm (wide) UB165-S

- Maximum graphic height (approx) 2435mm
- Height and width adjustable for maximum flexibility
- Lightweight and portable
- Simple to assemble and adapt for any environment

Total hardware dimensions (approx):
1000-2515 (h) x 1429-2540 (w) x 442 (d) mm



Watch video

Uno 2.2m

800mm (wide) UB101C-800-B-GR

1000mm (wide) UB101C-1000-B-GR

- Standard graphic height (approx) 2170mm
- Simple, lightweight and stable
- Variable height telescopic pole
- Optional fabric panel available

Total hardware dimensions (approx):
2210 (h - max) x 800-1000 (w) x 365 (d) mm



Lightning

800mm (wide) UB195-C

- Standard graphic height (approx) 1970mm
- Snap rail for easy graphic change
- Ideal budget banner for frequent graphic change
- Aluminium with anodised silver finish

Total hardware dimensions (approx):
2070 (h) x 805 (w) x 510 (d) mm

ONE
YEAR

Lite version available with less packaging, see page 41



Vortex

855mm (wide) UB722-C

- Standard graphic height (approx) 1800mm
- Free standing tension banner with simple eyelet system
- Easy to assemble
- Lite version available with minimum packaging, see page 42

Total hardware dimensions (approx):
1950 (h) x 855 (w) x 950 (d) mm



Understanding graphic printing media

There is a wide range of printing medias available to suit different applications. Here are some of the more popular types of media explained.

- **Economy Banner PVC:** Ideal for short-term; frequently changing presentations and outdoor banners
- **Standard Banner Polyester/Hybrid:** A durable substrate that retains its shape, ideal for mobile presentations and also for more permanent displays, 80% stop light
- **Premium Banner Polyester:** High-white giving excellent colour definition. Ideal for semi-permanent displays where a premium finish is required, 90% stop light
- **Pop-Up PVC:** PVC 550 micron, UV cure printed, suitable for indoor use
- **Standard Flag Knit:** 115g Polyester, textile fabric dye sublimation printed, suitable for outdoor and indoor use
- **Flag mesh:** 110gm textile fabric, ideal for outdoor flags
- **Display Polyester:** 210g textile fabric, dye sublimation printed, suitable for outdoor and indoor use

Desktop Banners

A range of mini banners to sit on your desk or for when space is restricted, ideal for branding or point of sale.



Breeze A4/A3

- A4 210mm (wide)** WH360
- A3 297mm (wide)** WH361

- Standard graphic height (approx) A4 297/ A3 420mm
- Self adhesive top rail
- Ideal budget banner for frequent graphic change
- Aluminium with anodised silver finish

Total hardware dimensions (approx):
 A4 - 335 (h) x 238 (w) x 80 (d) mm
 A3 - 440 (h) x 332 (w) x 82 (d) mm



Desktop Senator

- 360mm (wide)** UB100-001

- Standard graphic height (approx) 680mm
- Seamless graphic appearance
- Self adhesive rail
- Anodised silver finish tension banner

Total hardware dimensions (approx):
 680 (h) x 360 (w) mm



Desktop Zoom

- 255mm (wide)** UB723-C

- Standard graphic height (approx) 384.5mm
- Small, lightweight and compact
- Quick and easy to assemble
- Neat quill shape

Total hardware dimensions (approx):
 475 (h) x 270 (w) mm



Rigid Banners

Designed to support rigid substrates such as MDF, glass, acrylic or foam board up to 20mm. Ideal for when a more permanent display is required, shapes can also be cut out for greater visual impact



Fantasy 2

- 350mm (wide) UB251-350
- 500mm (wide) UB251-500

- Supports a variety of rigid materials from 3mm to 20mm thick depending on substrate
- Non-slip, robust and simple to use
- Base units can be used in pairs and multiples to support wider graphics

Total hardware dimensions (approx):
 UB251-350 130 (h) x 350 (w) x 400 (d) mm
 UB251-500 130 (h) x 500 (w) x 400 (d) mm



Wedge

- 300mm (wide) UB102-300-S
- 600mm (wide) UB102-600-S
- 800mm (wide) UB102-800-S
- 1000mm (wide) UB102-1000-S

- Supports a variety of rigid materials from 3mm to 40mm thick depending on substrate
- Graphic can be wider than base
- Wedge has been designed for quality and usability as well as easy storage

CNC service available for alternative graphic shapes at an extra cost.

Total hardware dimensions (approx):
 Base: 300/600/800/1000 (w) x 175 (d) mm

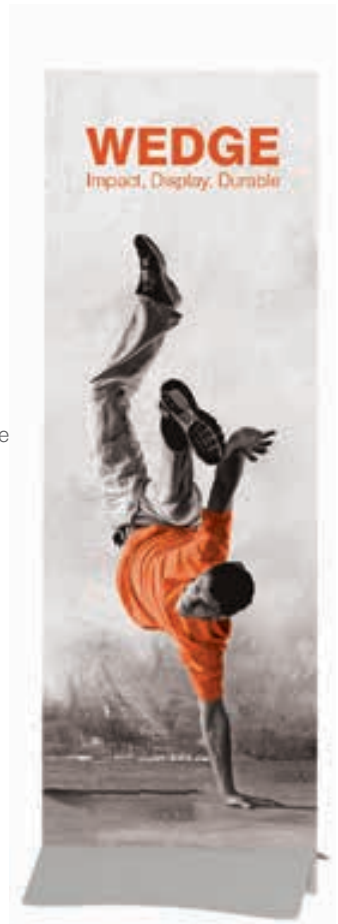

Rok

- Max 800mm (wide) UB104

- Supports rigid graphic panels in a variety of substrates
- Black moulded plastic base for water or sand weighting
- Ideal for signposting, directional display and outdoor events

Visible graphic area (approx):
 Foamex 900 (h) x 600 (w) mm
 MDF 1200 (h) x 800 (w) mm

Total hardware dimensions (approx):
 130 (h) x 120 (w) x 400 (d) mm



Shield

- 410mm (wide) UB108 with panel UB108B base only



- Ideal pavement advertiser, can be used indoors and out
- Rigid sign board with hard recycled rubber base complete with securing bolts
- Comes complete with two blank shapes
- Print your message onto the pre-stamped aluminium sheet using self-adhesive transfers or UV flat bed print

Visible graphic area (approx):
 800 (h) x 410 (w) x 1.2 (d) mm

Total hardware dimensions (approx):
 800 (h) x 465 (w) x 450 (d) mm



Grand Format Banners

Our grand format banner range offers some of the largest banners available, in extra wide or extra tall formats.



Original Banner 2

1200mm (wide)	Silver: UB322-1200A Black: UB322-1200B
1500mm (wide)	Silver: UB322-1500A Black: UB322-1500B
2000mm (wide)	Silver: UB322-2000A Black: UB322-2000B
2400mm (wide)	Silver: UB322-2400A Black: UB322-2400B

- Standard graphic height (approx) 2145mm
- Adjustable feet with hard wearing end plates
- Quick-change external slide in leader system and universal rail
- Wide range of widths available for use with Linear accessories (see page 7)

Total hardware dimensions (approx):
2240 (h) x 830/880/950/1030 (w)
x 195 (d) mm
2400mm (w) available on request

Available in an impressive 2400mm wide

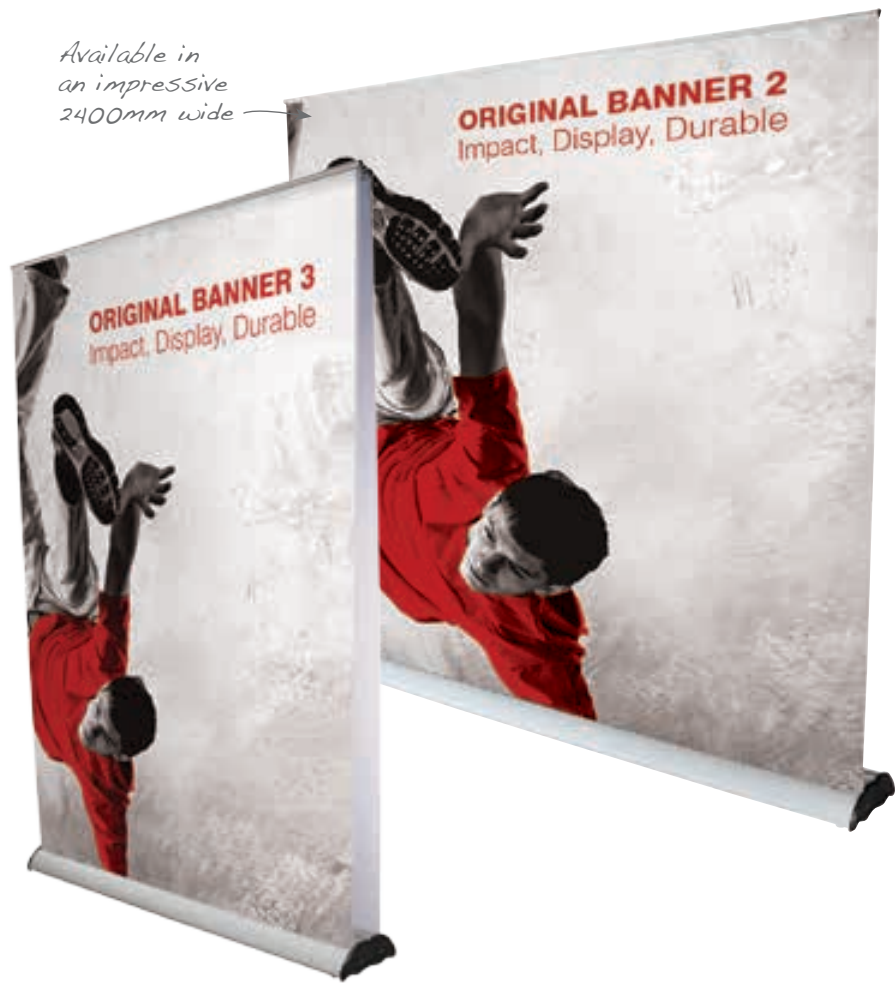

Original Banner 3

1200mm (wide)	Silver: UB302-1200A Black: UB302-1200B
1500mm (wide)	Silver: UB302-1500A Black: UB302-1500B
2000mm (wide)	Silver: UB302-2000A Black: UB302-2000B
2400mm (wide)	Silver: UB302-2400A Black: UB302-2400B

- Standard graphic height (approx) 2145mm
- Available as single or double sided
- Adjustable feet with hard wearing end plates
- Quick-change external slide in leader system and universal rail

Total hardware dimensions (approx):
2240 (h) x 830/880/950/1030 (w)
x 195 (d) mm
2400mm (w) available on request



Watch video

Available up to 2000mm wide

Orient

1200mm (wide)	WH353-1200-001
1500mm (wide)	WH353-1500-001
2000mm (wide)	WH353-2000-001

Please note 1200/1500/2000mm are available single sided only. (Double pole)

- Standard graphic height (approx) 2110mm
- Graphic pulls up from the front for floor to rail visibility
- Adjustable feet for levelling
- Snap rail

Total hardware dimensions (approx):
2160 (h) x 1230/1580/2080 (w) x 185 (d) mm

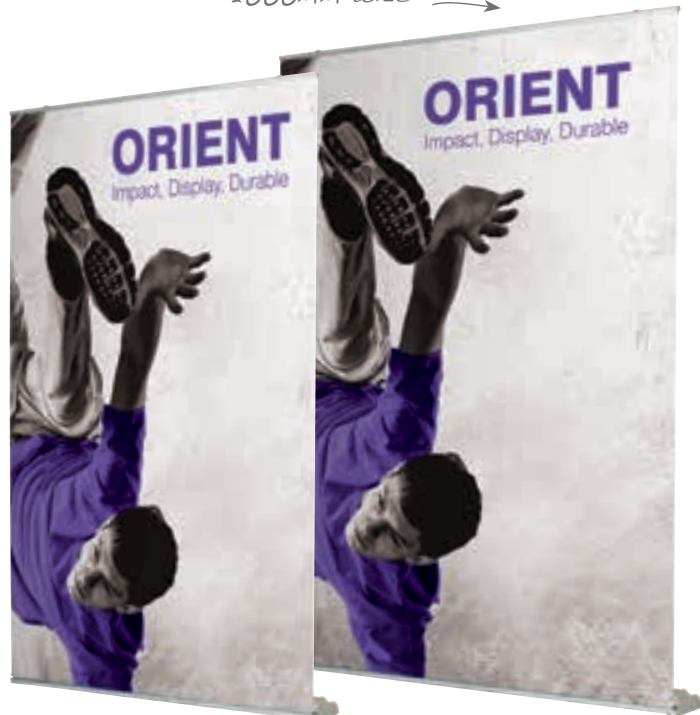

**FIVE
YEAR**



Aero (Modular)

- 1000mm (wide)** UB213-1000
- 1500mm (wide)** UB213-1500
- 2000mm (wide)** UB213-2000

- Adjustable graphic heights 1010mm/1510mm/2010mm
- Linkable and reconfigurable roller banner system
- Multiple positions to suit area

Total hardware dimensions* (approx):
2120 (h) (max) x 4430 (w) x 405 (d) mm
2120 (h) (max) x 2065 (w) x 1565 (d) mm

*depends on configuration



Pegasus

- 1500 - 2410mm (wide)** UB165-S

- Maximum graphic height (approx) 2435mm
- Height and width adjustable for maximum flexibility
- Lightweight and portable
- Simple to assemble and adapt for any environment

Total hardware dimensions (approx):
1000-2515 (h) x 1429-2540 (w) x 442 (d) mm



Watch video

Grand Format Banners

Our grand format banner range offers some of the largest banners available, in extra wide or extra tall formats.



Giant Mosquito

NEW Available up to 2000mm wide!

- 1200mm (wide)** UB300-1200
- 1500mm (wide)** UB300-1500
- 2000mm (wide)** UB300-2000

- Standard graphic height (approx) 3000mm
- One of the largest economy banners you can buy
- Hybrid pole can be set at various heights up to 3m
- Twin twist out feet and snap rail

Total hardware dimensions (approx): 3100mm (h) x 869/1019mm (w) x 400mm (d)



Mosquito

- 1200mm (wide)** UB197-1200
- 1500mm (wide)** UB197-1500
- 2000mm (wide)** UB197-2000

- Standard graphic height (approx) 1992mm
- Available in seven different widths 600/800/850/1000/1200/1500/2000mm
- Quality snap rail
- Twin twist out feet

Total hardware dimensions (approx): 2105 (h) x 860 (w) x 285 (d) mm



Grasshopper

NEW Available up to 1500mm wide

- 1200mm (wide)** UB191-1200
- 1500mm (wide)** UB191-1500

- Standard graphic height (approx) 2000mm
- Twin twist out feet
- Self adhesive graphic fixing
- Available 800 - 1500mm widths

Total hardware dimensions (approx): 2098 (h) x 860 (w) x 285 (d) mm





OUTDOOR/ INDOOR

Freedom, Impressive, Robust

Our impressive outdoor/indoor collection provides a great range of products.

Perfect for outdoor situations such as sporting events, country shows and trade fairs as well as indoor purposes including exhibitions, retail promotions and showrooms.

Formulate Storm is a robust flag system with a choice of two different shapes 90 and Curve, each flag shape uses one pole that can accommodate either 3.6m or 4.8m pole heights.

Formulate Storm

UB732 -C/ UB733 -C

- Strong durable flag poles made from 30mm Aluminium tube
- Choice of bases to suit most surfaces
- Beaufort scale 4 free-standing (13-18mph/21-29kph)
- Beaufort scale 5 if pegged (18-24mph/29-38kph)

Visible graphic area (approx):
 Storm 90 3.6m - 2400 (h) x 840 (w) mm
 Storm 90 4.8m - 3600 (h) x 840 (w) mm
 Storm Curve 3.6m - 2400 (h) x 425 (w) mm
 Storm Curve 4.8m - 3600 (h) x 425 (w) mm



Formulate Storm base options



Large Cross Base* / UF-ZMLCB



Square Base / UF-ZMLSQ



Weighting Ring / UB719-C



Ground Spike* / UF-ZMGS



Drive-on Car Foot / UF-ZMCF5



Concrete Base** / UF-ZMCEM

NEW

*Only large cross base and ground spike suitable with 4.8m versions.

**Concrete base only suitable on 3.6m versions

Recommended to use weighting ring with large cross base.

Zoom Lite

UF-ZM28 / UF-ZM34 / UF-ZM45 / UF-ZM56

- Flexible flag system designed to give you a choice of pole sizes from 2.8m to 5.6m
- Four flag shapes - Quill, Crest Feather and Edge*
- Multiple bases to suit most surfaces
- Beaufort scale 4 (13 -18 mph/21-29kph)

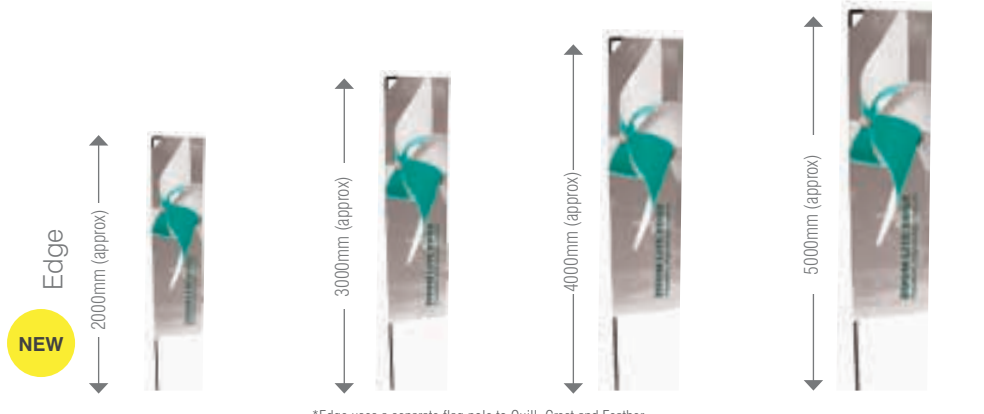

*Edge uses a separate flag pole to Quill, Crest and Feather

Zoom Lite base options

-  Cross Base / UF-ZMSCB**
-  Weighting Ring / UB719-C
-  Ground Stake / UF-ZMPSS**
-  Ground Spike* / UF-ZMGS
-  Wall Mounting Base** / UF-ZMWMF NEW
-  Square Base / UF-ZMLSQ
-  Large Cross Base* / UF-ZMLCB
-  Drive-on Car Foot / UF-ZMCF5*
-  Outdoor Water Base** / UF-ZMGMB NEW
-  Concrete Base*** / UF-ZMCEM NEW

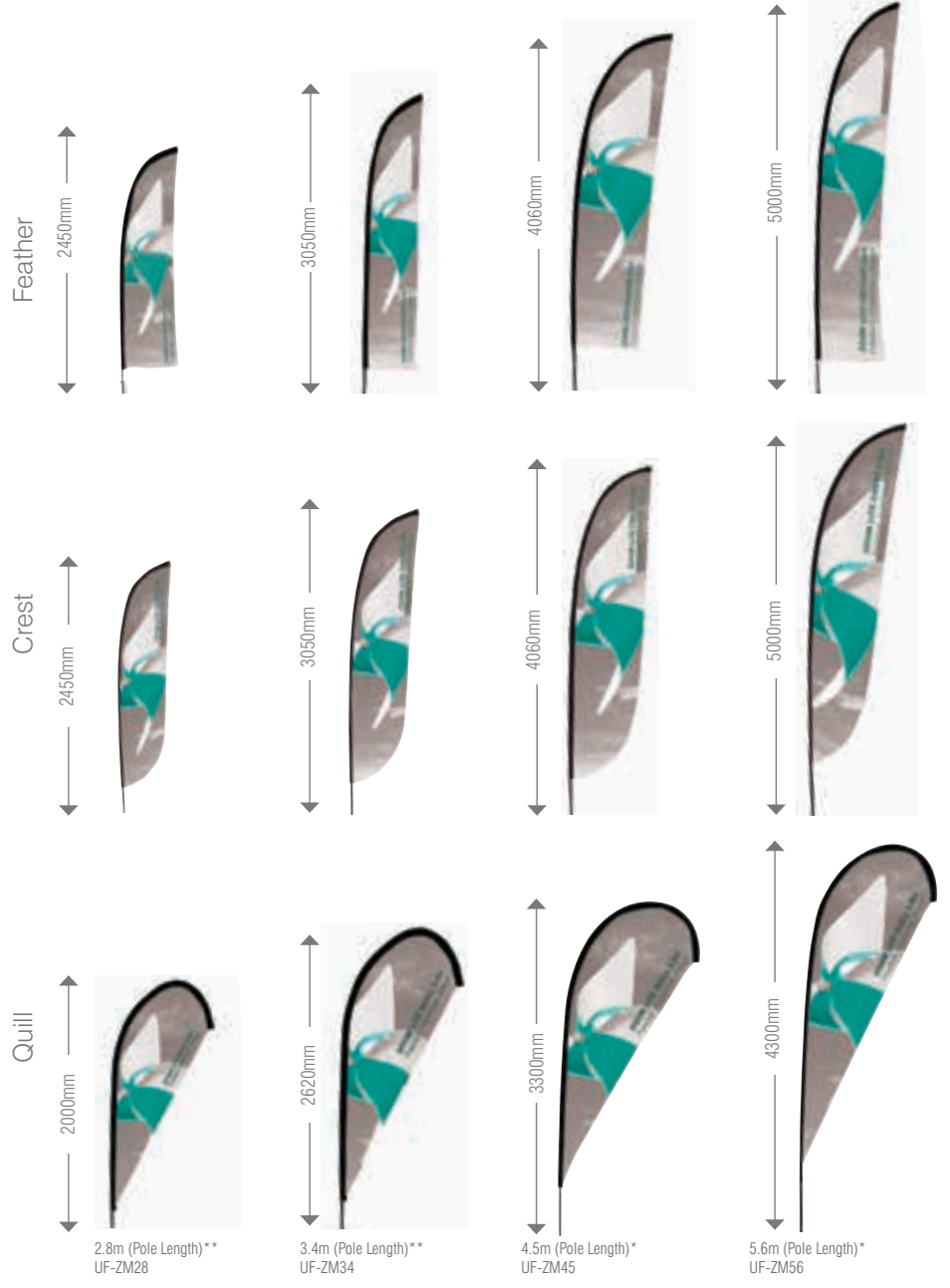

*Suitable for use with 4.5m & 5.6m versions.
 **Suitable for use with 2.8m & 3.4m versions.
 ***Suitable for use up to 4.1m

Feather
 Visible graphic area (approx):
 2.8m - 2000 (h) x 550 (w) mm
 3.4m - 2600 (h) x 600 (w) mm
 4.5m - 3400 (h) x 796 (w) mm
 5.6m - 3900 (h) x 850 (w) mm

Crest
 Visible graphic area (approx):
 2.8m - 1900 (h) x 500 (w) mm
 3.4m - 2600 (h) x 600 (w) mm
 4.5m - 3400 (h) x 785 (w) mm
 5.6m - 3900 (h) x 850 (w) mm

Quill
 Visible graphic area (approx):
 2.8m - 1530 (h) x 680 (w) mm
 3.4m - 2058 (h) x 990 (w) mm
 4.5m - 2900 (h) x 1200 (w) mm
 5.6m - 3600 (h) x 1204 (w) mm

Optional carry bags:
 2.8/3.4m - AB-ZMS
 4.8/5.6m - AB-ZML
 Base bag - AB108

Flags

Outdoor/Indoor

One of the most visual and striking ways of promoting your business outdoors, with a wide choice of bases and styles flags are an ideal way to promote your business.

ONE YEAR

Outdoor/Indoor / Flags

Zoom Feather & Quill

UB724-C / UB717-C

- Lightweight portable outdoor flag
- Aluminium base section with glass fibre pole, which makes it easy for transportation
- Choice of bases to suit a range of applications
- Beaufort scale 4 (13 - 18 mph/21-29kph)

Visible graphic area (approx):
 Feather 4.7m - 4025 (h) x 870 (w) mm
 Feather 3.5m - 3025 (h) x 870 (w) mm
 Quill 4.1m - 3575 (h) x 1480 (w) mm
 Quill 3.5m - 3108 (h) x 1480 (w) mm

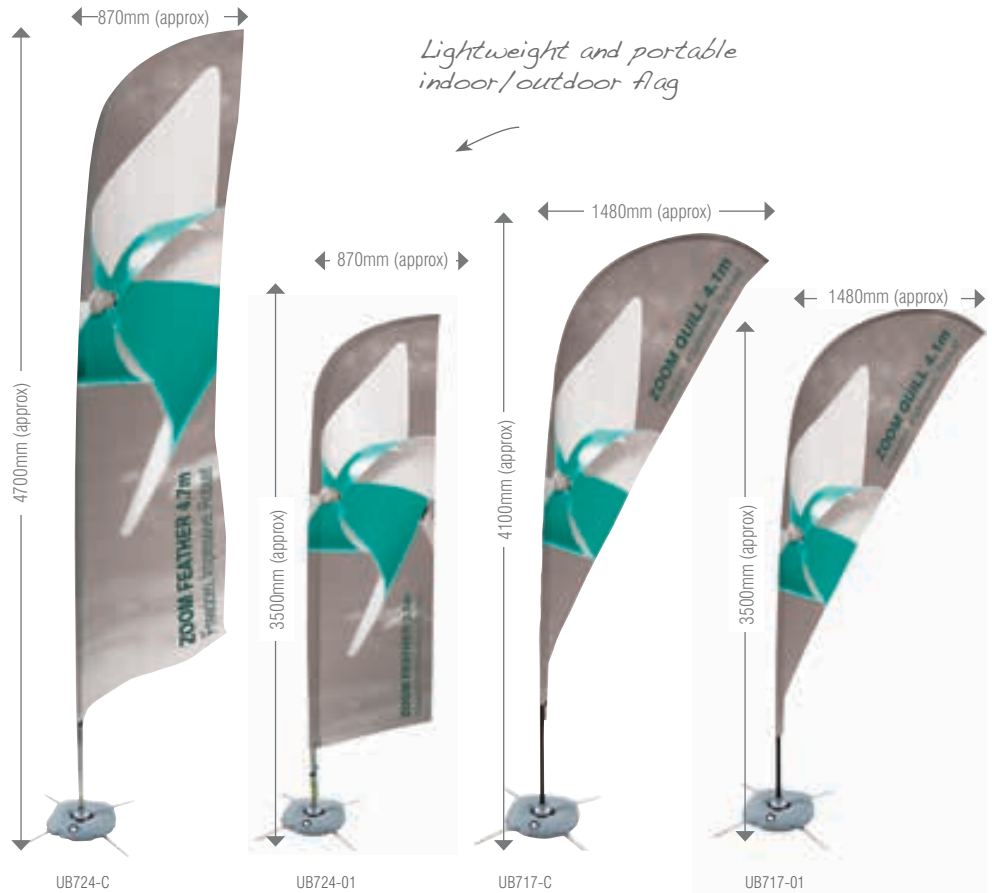

Zoom base options



Base Foot (includes bag) / UB718-C
Recommended to use weighting ring with large cross base.



Weighting Ring / UB719-C
(sold separately - includes bag)



Ground Spike / UB720-C



Drive-on Car Foot / UB721-C
(bag not included)



Concrete Base / UF-ZMCEM
(suitable up to 4.1m flags)
Female adapter (optional extra)

Mini Zoom Kit

UB726-C

- Glass fibre pole can be assembled in different heights, up to approx. 2.5 metres
- Choice of steel base or ground spike included
- Beaufort scale 4 (13 - 18 mph/21-29kph)

Visible graphic area (approx):
 1.8m - 1800 (h) x 842 (w) mm
 2.5m - 2148 (h) x 1169 (w) mm

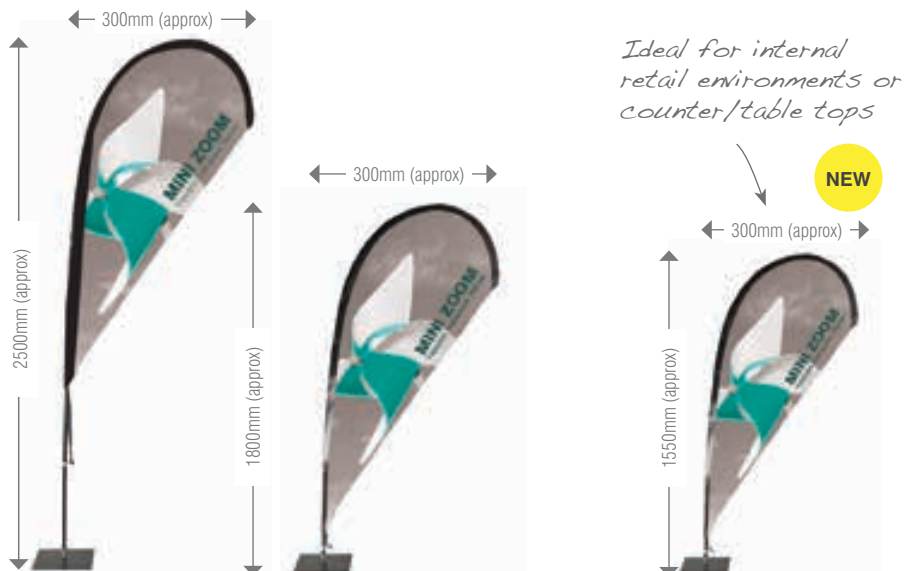

Mini Zoom base options



Ground Spike* / UB726-GS Square Base / UB726-B

Zoom Grande 
UB730-C

- Tough telescopic pole for adjustable height up to approx 5.8m high
- Choice of bases to suit most surfaces
- Suitable for both Quill and Feather shaped lightweight fabric graphics
- Beaufort scale 4 (13 - 18 mph/21-29kph)

Visible graphic area (approx):
Quill - 4502 (h) x 1400 (w) mm
Feather - 4600 (h) x 1050 (w) mm

The tallest and strongest outdoor flag



Zoom Grande base options



Aqua Zoom Kit 
UB116

- Kit includes anchor to keep in position in water, tether rope to retrieve flag from water, galvanised steel counter weight, pole and base
- Pole constructed using the tough Zoom Grande design
- For use in rivers, ponds and lakes with a minimum water depth of 1.2m and maximum 3.4m

Visible graphic area (approx):
Aqua Zoom Feather 2600 (h) x 600 (w) mm
Aqua Zoom Quill 2058 (h) x 990 (w) mm

Total hardware dimensions (approx):
Aqua Zoom Feather 3700 (h) x 785 (w) mm
Aqua Zoom Quill 3200 (h) x 1155 (w) mm

Hard-wearing flag for use in water

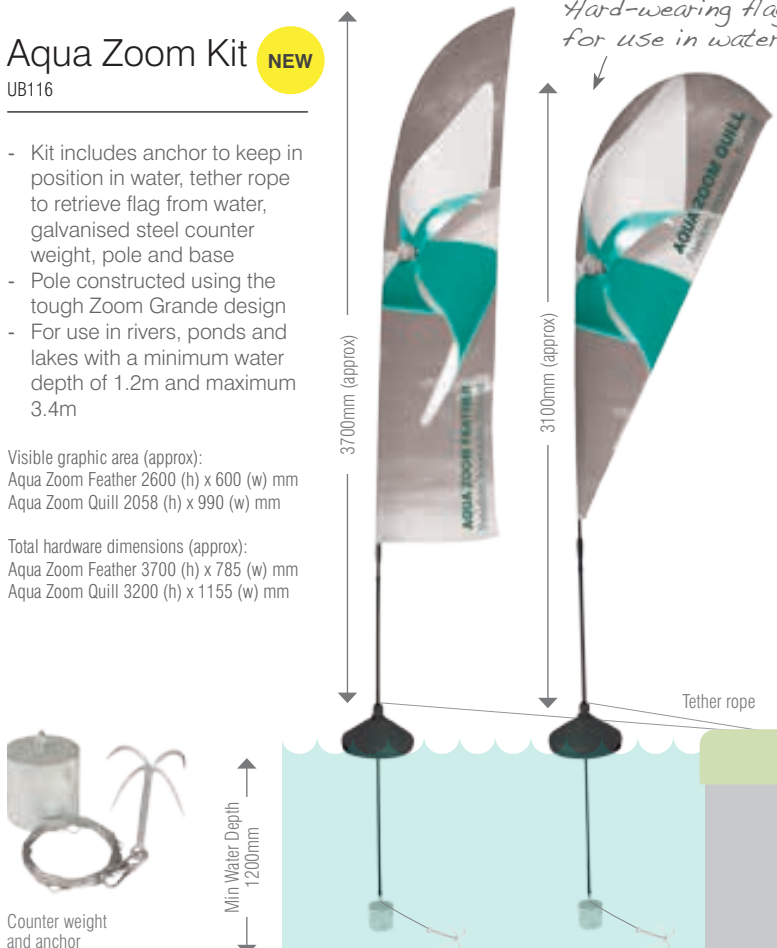

IMPORTANT INFORMATION
How to care for your flags

1. Consider where you position your flag as pollution will cause the white areas of a flag to become grey and UV can, overtime cause deterioration and fading of the flag
2. Life expectancy is entirely dependent on the climatic conditions and hours of flying. Realistic maximum life span of a flag in regular use is six months
3. Take down your flag in strong winds over force six. Heavy rain combined with high winds increases the weight of the flag and thus the wind-loading exerted on the pole
4. Flags can be washed in a regular washing machine on a 40° wash with normal detergents. If the end of the flag is frayed - trim, reinforce and re-hem to extend the life
5. Make sure that your flag cannot catch or snag on the pole or another object nearby, as this will cause damage. Do not site poles too close together
6. Never store your flag when wet. Always hang it up and allow it to dry before storing

Flags

Outdoor/Indoor

One of the most visual and striking ways of promoting your business outdoors, with a wide choice of bases and styles flags are an ideal way to promote your business.

ONE YEAR

Outdoor/Indoor / Flags

Wind Dancer

WD104 (4m) / WD105 (5m)

- 4 or 5m high telescopic flag pole
- The base unit can be filled with water or sand for extra stability
- Portable and lightweight with eyelet fixings for graphics
- Beaufort scale 4 (13 -18 mph/21-29kph)

Visible graphic area (approx):
4m - 2800 (h) x 800 (w) mm
5m - 3500 (h) x 1000 (w) mm

Optional bag:
4m - AB212-C
5m - UB716-C



Shimmer

WD102

- Outdoor/indoor flag pole with hollow base for sand or water weighting
- Plastic, easy push-fit assembly with adjustable height; black pole and base
- Suitable for lightweight flag knit graphic
- Quality construction based on Zoom Grande design
- Optional concrete base available (UF-ZMCEM)

Visible graphic area (approx):
1800 (h) x 550 (w) mm

Total hardware dimensions (approx):
2560 (h) x 800 (w) mm

For indoor, use vinyl PVC or textile fabric



Eco

WD101

- Economy 2.9m flag pole with plastic easy push-fit assembly
- Suitable for lightweight flag textile fabric
- 8 litre capacity base
- White adjustable pole with white base

Visible graphic area (approx):
1800 (h) x 550 (w) mm

Total hardware dimensions (approx):
2940 (h) x 840 (w) mm
Base 350mm dia.



Mistral

UB725

- Display your message from either lamp post or wall
- Brackets can be moved for adjustable graphic height using fabric or vinyl
- Made from weatherproof aluminium castings and GRP tubes

Visible graphic area (approx):
2000 (h) x 800 (w) mm

Strongly recommend wind slits for continuous use in all weather conditions. Slits de-power banner flags.

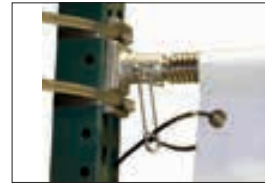

Bracket can be moved to graphic height

Double Sided Mistral

UB725-D

- Mount graphics on lamp posts using both sides of your post
- Brackets can be moved for adjustable graphic height using fabric or vinyl
- Made from weatherproof aluminium castings and GRP tubes

Visible graphic area (approx):
2000 (h) x 800 (w) mm

Strongly recommend wind slits for continuous use in all weather conditions. Slits de-power banner flags.

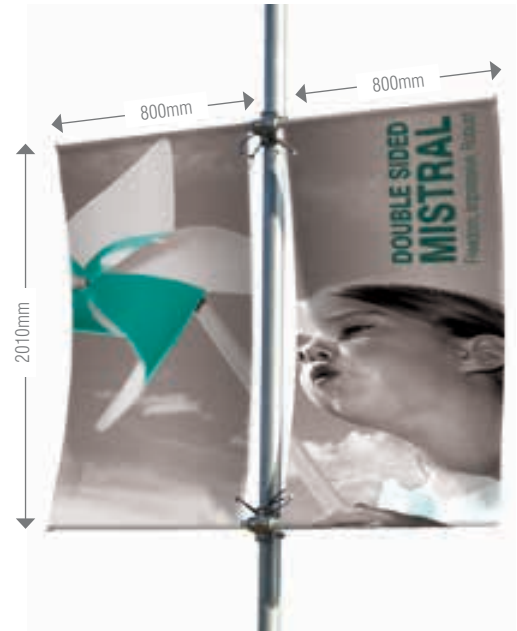

Rotating Mistral

UB725-R

- Mounted to posts or wall on an extended arm, allowing the graphic to rotate in the wind
- Brackets can be moved for adjustable graphic height
- Suitable for fabric or vinyl graphics

Visible graphic area (approx):
1500 (h) x 800 (w) mm

Strongly recommend wind slits for continuous use in all weather conditions. Slits de-power banner flags.

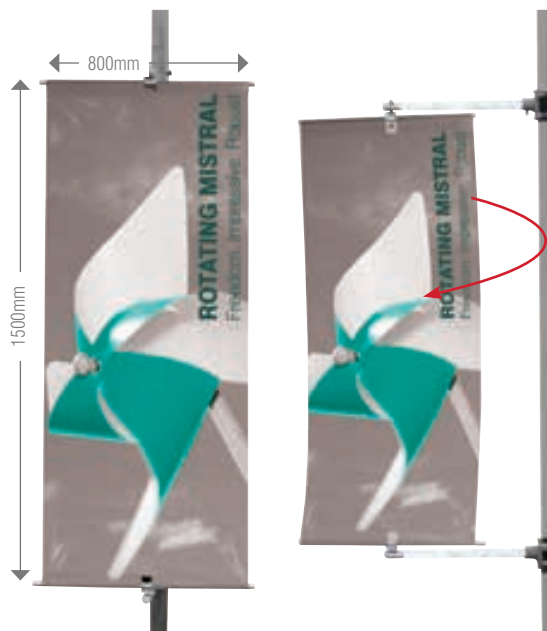

Banners
Outdoor/Indoor

We have specially designed banners for outdoor use.
 Choose from single or double sided, large format or A frame styles.



A double-sided retractable outdoor banner. Thunder is the ideal roller banner for outdoor use being strong and durable yet very easy to assemble and transport. At 2m high Thunder will display your message on both sides for maximum viewing impact.

Thunder

850mm (wide) UB185-850

- Standard graphic height (approx) 2025mm
- 2m high double sided retractable banner
- Large twin feet and snap rail
- Three part bungee pole
- Beaufort scale 5 if pegged (18-24mph/29-38kph)
- Beaufort scale 2 if unpegged (4-7mph/6-11kph)

Total hardware dimensions (approx):
 2080 (h) X 900 (w) X 820 (d) mm



Three part bungee pole



Twist lock feet



Wide feet for stability



Pegs included to secure to ground



End profile



Hurricane

NEW

800mm (wide) UB700

- Standard graphic height (approx) 1960mm
- Single or double outdoor tension banner
- Graphics attached using self-adhesive slider rail
- Water filled base, holds up to 28 litres
- Two spring loaded poles for extra wind resistance
- Beaufort scale 4 (13-18 mph/21-29kph)

Total hardware dimensions (approx):
2200 (h) x 1020 (w) x 780 (d) mm



Blizzard

800mm (wide) UB701-C

- Standard graphic height (approx) 2000mm
- Stylish design with hollow plastic base for water or sand weighting
- Telescopic pole for adjustable height
- Adjustable rail for variable graphic width
- Beaufort scale 4 (13-18 mph/21-29kph)

Total hardware dimensions (approx):
2100 (h) x 800 (w) x 540 (d) mm

Optional bag:
AB140-C



Storm Hydro 2

800mm (wide) UB209

- Standard graphic height (approx) 1800mm
- Single or double sided indoor/outdoor banner
- Weather resistant
- Moulded plastic base for water or sand weighting
- Beaufort scale 3 (10-12mph/16-19kph)

Total hardware dimensions (approx):
2135 (h) x 813 (w) x 533 (d) mm



Stowaway

- 1400mm (wide)** UB736-03
- 1700mm (wide)** UB736-02
- 2000mm (wide)** UB736-01

- Highly portable and visual impact display stand
- Supplied with carry bag and ground pegs
- Spring fibreglass poles pack away in to a small carry bag

Visible graphic area (approx):
650 (h) x 1354 (w) mm
820 (h) x 1650 (w) mm
990 (h) x 1962.5 (w) mm

Total hardware dimensions (approx):
700 (h) x 1420 (w) x 400-480 (d) mm
850 (h) x 1720 (w) x 400-480 (d) mm
1000 (h) x 2020 (w) x 400-480 (d) mm



Banners Outdoor/Indoor

We have specially designed banners for outdoor use.
Choose from single or double sided, large format or A frame styles.



Horizon

2500mm (wide) UB203

- Adjustable graphic height (approx) 1500-2400mm
- Single or double sided banner system
- Telescopic pole for adjustable height giving up to 4.8m2 per side
- Individual units can be joined together to form a wall with hollow feet for water or sand weighting
- Beaufort scale 3 (10-12mph/16-19kph)

Total hardware dimensions (approx):
Overall height 3000mm
Base tank dimensions: 800mm x 2400mm



Monsoon, Wall and Mini Monsoon

1250mm (wide) UB708-C

2500mm (wide) UB707-C

3000mm (wide) UB711-C

- Three double sided A frame banners suitable for outdoor or indoor use. Also available in wall mounted option
- Easy push-fit assembly with plastic flush-fit joining, no tools necessary
- Graphic secured with adjustable looped elastics and supplied with guide pegs
- Beaufort scale 5 (18-24mph/29-38kph)

Visible graphic area (approx):
1090 (h) x 1090 (w) mm
840 (h) x 2340 (w) mm
1090 (h) x 2840 (w) mm

Total hardware dimensions (approx):
1250 (h) x 1250 (w) mm
1000 (h) x 2500 (w) mm
1250 (h) x 3000 (w) mm

Available up to 3000mm wide

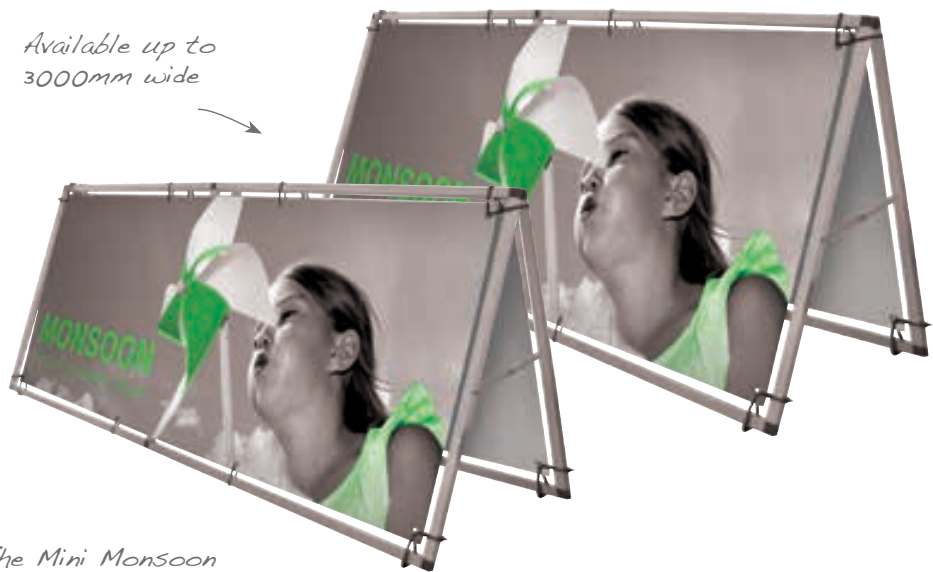

The Mini Monsoon is ideal for windy outdoor events where space is limited

Single sided wall banner available

NEW



UB708-C

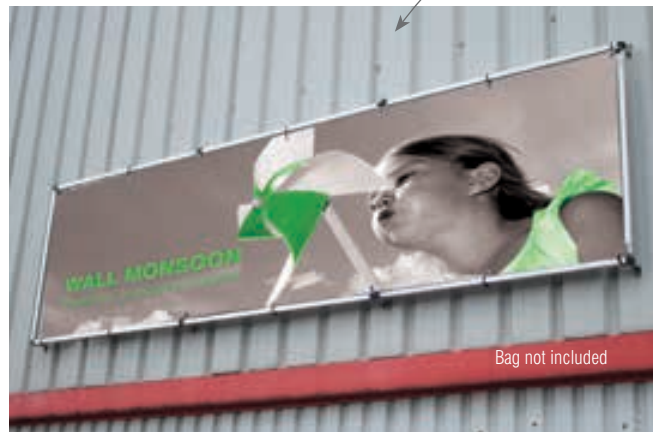

Bag not included

Sign Boards

Outdoor/Indoor

Ideal pavement advertisers for outside shops, restaurants or bars.
Insert your artwork in a choice of double sided frames.

ONE
YEAR

Whirlwind

UB207

- Heavy-duty double sided outdoor swing sign that is ideal for pavement advertising and retail promotions
- Wheeled compact moulded hollow base for water or sand weighting
- Spring pivot for swing motion and packs flat for easy transportation

Visible graphic area (approx):
A1 - 820 (h) x 575 (w) mm

Total hardware dimensions (approx):
1165 (h) x 780 (w) x 500 (d) mm



A-Sign Board

VF204-C/A2

- Double-sided snap frame suitable for A1 and A2 size posters
- New B1 and B2 sizes available soon
- Easy front loading
- Galvanised steel backing adding extra strength and stability

Visible graphic area (approx):
A1 831 (h) x 584 (w) mm
A2 594 (h) x 420 (w) mm

Total hardware dimensions (approx):
A1 1060 (h) x 638 (w) x 825 (d) mm
A2 925 (h) x 465 (w) x 675 (d) mm



Shield

UB108 with panel/UB108B base only

NEW

- Ideal pavement advertiser, can be used indoors and out
- Rigid sign board with hard recycled rubber base complete with securing bolts
- Comes complete with two blank shapes
- Print your message onto the pre-stamped aluminium sheet using self-adhesive transfers or UV flat bed print

Visible graphic area (approx):
800 (h) x 410 (w) x 1.2 (d) mm

Total hardware dimensions (approx):
800 (h) x 465 (w) x 450 (d) mm



Chaser

UB113

NEW

- Double sided display unit
- Stylish powder-coated oval tubular frame and black recycled PVC base with excellent stability
- Gloss white aluminium panel
- Blank spares available

Visible graphic area (approx):
789 (h) x 519 (w) mm

Total hardware dimensions (approx):
959 (h) x 590 (w) x 407 (d) mm



Sign Boards

Outdoor/Indoor

Ideal pavement advertisers for outside shops, restaurants or bars.
Insert your artwork in a choice of double sided frames.

ONE
YEAR

Rok

UB104

- Supports rigid graphic panels in a variety of substrates
- Black moulded plastic base for water or sand weighting
- Ideal for signposting, directional display and outdoor events

Visible graphic area (approx):
Foamex 900 (h) x 600 (w) mm
MDF 1200 (h) x 800 (w) mm

Total hardware dimensions (approx):
130 (h) x 120 (w) x 400 (d) mm



Sign Board Lite

VF205

- Strong and durable sign board made from high impact polystyrene sheets and internal hinged mechanism
- Large graphic area ideal for self adhesive or cut vinyl graphics
- Easy to use and cost effective

Total hardware dimensions (approx):
750 (h) x 500 (w) x 380 (d) mm



Trojan

SP-TRO

- Free-standing portable and linkable information unit
- Hollow base can be weighted with water or sand
- Supplied flat pack in three plastic pieces

Visible graphic area (approx):
380 (h) x 330 (w) mm

Total hardware dimensions (approx):
1200 (h) X 380 (w) mm



Durable and weather proof

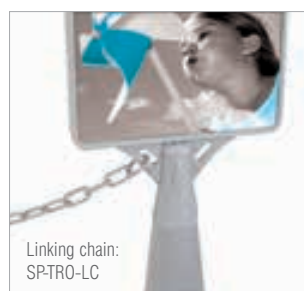

Linking chain:
SP-TRO-LC

Limpit

SP-LIM

- Promoter unit with suction cup system for use on smooth surfaces, car roofs or glass
- Easy to use and reposition with suction cup system
- Accepts material up to 10mm thick

Visible graphic area (approx):
Variable

Total hardware dimensions (approx):
Suction cup 120mm dia.



Economy Cafe Barrier

UB214

- Cost effective way of defining areas outside restaurants, bars and shopping centres
- Heavyweight black post and concrete base
- Graphic attached with spring clips at the bottom
- Sold as individual components

Visual graphic area (approx):
1000mm - 675 (h) x 850 (w) mm
1500mm - 675 (h) x 1350 (w) mm
2000mm - 675 (h) x 1850 (w) mm

Total hardware dimensions (approx):
Rail - 1440/1940/2440mm
Post - 960mm (h)
Base - 360mm (dia.)



Rail
UB214-1000
UB214-1500
UB214-2000

Post - UB214P
Base - UB214B
Spring Clips - UB214-SC



(Cannot be left outside in all weathers)

Deluxe Cafe Barrier

UB215

- Stylish way for defining areas outside restaurants, bars and night clubs
- Heavyweight stainless steel post and concrete base
- Sold as individual components
- Low cost Basics option available (see page 43)

Visual graphic area (approx)
1000mm - 775 (h) x 850 (w) mm
1500mm - 775 (h) x 1350 (w) mm
2000mm - 775 (h) x 1850 (w) mm

Total hardware dimensions (approx):
Rail - 1440/1940/2440mm
Post - 960mm (h)
Base - 360mm (dia.)



Rail
UB215-1000
UB215-1500
UB215-2000

Post - UB215P
Base - UB215B

Recommend using top and bottom rails



(Cannot be left outside in all weathers)

Leader Rope & Pole

LB908

- Strong, durable exhibition and event queue guidance system
- Rope available in red, burgundy, blue or black and two sizes 1000mm/1500mm
- Metalwork in a smooth black or grey powder coated finish
- Low cost Basics option available (see page 43)

Total hardware dimensions (approx):
Post - 950mm
Rope - 1000/1500mm
Base - 350mm (dia.)
(For indoor use only)



Leader Plus

LB801/LB802

- Leader Plus is a smart retractable barrier system, ideal for use in areas such as retail outlets, airports and entertainment venues
- Each post is available in chrome or black can be connected to additional barriers to create customised configurations to any length
- Webbing retracts into post unit with anti-tamper tape ends
- Low cost Basics option available (see page 43)

Total hardware dimensions (approx):
Post 910mm
Tape 2000mm
Base 360mm (dia.)
(For indoor use only)

Webbing can extend to 2m long



Tornado

PK410

- Constructed from moulded NDPE and PVC tambour
- Moulded top with pen recess and water drainage notches
- Hollow base for water or sanding weighting plus tambour wrap included
- Suitable for indoor and outdoor use

*Header and support poles optional extra (PK411)

Visible graphic area (approx):
Base: 872 (h) x 950 (w) mm
Header: 250 (h) x 675 (w) mm

Total hardware dimensions (approx):
1040 (h) x 850 (w) x 500 (d) mm
PVC wrap: 900 (h) x 2070 (w) mm
Header: 250 (h) x 600 (w) mm

 Optional carry bags:
Base bag - AB187
Pole bag - AB187A



Counta

PC607

- Lightweight, portable and cost effective demonstrator unit
- Includes rigid header panel, shelf and twin supporting poles
- Graphics can be applied as vinyl, or screen print directly onto the plastic base wrap
- Indoor use only

Visible graphic area (approx):
Base: 770 (h) x 816 (w) mm
Header: 280 (h) x 770 (w) mm

Total hardware dimensions (approx):
Base: 850 (h) x 810 (w) x 470 (d) mm
Header: 285 (h) x 775 (w) mm



Zoom Tent kit

NEW

ZT33-XAF

- Zoom Tent kit 3x3m includes frame and ground pegs, quick and easy to assemble and can shade up to 5 people
- Available options include:
Full wall, half wall with tube and clamp, water filled weights, 3.5m guide ropes, wheeled bag and printing
- Available in four colours black, blue, white and red



Optional full and half wall



Optional tent weights



Optional full back wall



BASICS

Simple, Competitive, Effective

Basics is a range of display products designed to be economical and cost effective.

Ideal for when you need simple yet effective methods of displaying your message.



Grasshopper is an extremely popular roller banner; it's ideal for promotions, exhibitions and events for when you need a quick and simple solution.

Grasshopper

800mm (wide) UB191

850mm (wide) UB193

1000mm (wide) UB191-1000



Also available in grand format sizes up to 1500mm wide. For more details see page 23.

- Standard graphic height (approx) 2000mm
- Twin twist out feet
- Self adhesive graphic fixing
- Available 800-1500mm widths
- Double layered bag included

Total hardware dimensions* (approx):
2098mm (h) x 860mm (w) x 285mm (d)
Based on 800mm (w) banner



Watch video



End profile of base



Pole reinforcer



Twist out feet

Wasp

- 800mm (wide)** UB204-800-03
- 850mm (wide)** UB204-850-03
- 1000mm (wide)** UB204-1000-03

- Standard graphic height (approx) 2000mm
- Double twist out feet
- Snap rail
- Bungee pole
- Simple and effective

Total hardware dimensions (approx):
2080 (h) x 815/865/1015 (w) x 320 (d) mm

Our lowest cost roller banner →



Mayfly

- 800mm (wide)** UB210-800
- 850mm (wide)** UB210-850

- Standard graphic height (approx) 2000mm
- Twin twist out feet
- Self adhesive graphic fixing
- Bungee pole

Total hardware dimensions (approx):
2090 (h) x 816/866 (w) x 350 (d) mm

Self adhesive rail →



Firefly

- 800mm (wide)** UB206-800
- 850mm (wide)** UB206-850
- 1000mm (wide)** UB206-1000

- Standard graphic height (approx) 2000mm
- Twin twist out feet
- Snap rail
- Bungee pole

Total hardware dimensions (approx):
2090 (h) x 816/866/1016 (w) x 350 (d) mm

Snap rail →



Dragonfly

- 850mm (wide)** UB199-850-01
- 1000mm (wide)** UB199-1000-01

- Standard graphic height (approx) 2000mm
- Double sided
- Snap rail
- Twist out foot
- Bungee pole

Total hardware dimensions (approx):
2120 (h) x 865 (w) x 380 (d) mm

Double sided banner but can be used as single if required →



Basics Range

Basics products include a wide range of banners, pedestrian guidance systems, plus hop-up and pop-up display systems all at great value for money.



ONE YEAR

Mosquito

Available in 7 widths →

600mm (wide) UB197-600

800mm (wide) UB197

850mm (wide) UB196

1000mm (wide) UB197-1000



Also available in grand format sizes up to 2000mm wide. For more details see page 23.

- Standard graphic height (approx) 1992mm
- Quality snap rail
- Twin twist out feet
- Double layered bag included

Total hardware dimensions (approx):
2105 (h) x 860 (w) x 285 (d) mm
Based on 850mm banner



Watch video



Giant Mosquito

Up to 3m tall →

850mm (wide) UB300-850

NEW

1000mm (wide) UB300-1000



Also available in grand format sizes up to 2000mm wide. For more details see page 23.

- Standard graphic height (approx) 3000mm
- One of the largest economy banners you can buy
- Hybrid pole can be set at various heights up to 3m
- Twin twist out feet and snap rail

Total hardware dimensions (approx):
3100mm (h) x 869/1019mm (w) x 400mm (d)



Mini Mosquito

NEW

600mm (wide) UB197-600-01

Ideal for retail applications →

- Standard graphic height (approx) 1600mm
- Quality snap rail with twist out foot
- Anodised silver finish

Total hardware dimensions (approx):
1615 (h) x 600 (w) mm



Lightning Lite

800mm (wide) UB195

- Standard graphic height (approx) 1970mm
- Snap rail for easy graphic change
- Ideal budget banner for frequent graphic change
- Aluminium with anodised silver finish

Total hardware dimensions (approx):
2070 (h) x 805 (w) x 510 (d) mm

Quick change budget banner →



Vortex Lite

Very lightweight →

855mm (wide) UB722-01

- Standard graphic height (approx) 1800mm
- Very lightweight
- Quick and easy to assemble
- Graphics housed separately for easy change

Total hardware dimensions (approx):
1950mm (h) x 855mm (w) x 950mm (d)



Impact Hop-up

HUI3X2/3X3/3X4/3X5

- Lightweight hop-up system that's very quick and easy to set up, complete with carry bag
- Fabric fits smoothly across the frame work and stays in place once frame has been collapsed
- Single sided with yellow locking arms

Visible graphic area (approx):
3x2 - 2262 (h) x 2222 (w) mm
3x3 - 2262 (h) x 2960 (w) mm
3x4 - 2262 (h) x 3698 (w) mm
3x5 - 2262 (h) x 4436 (w) mm

Total hardware dimensions (approx):
2260 (h) x 1525/2260/2995/3730(w)
x 295 (d) mm



*Optional feet and lights

Impact Bundle

3X3: 99-XX-071 3X4: 99-XX-070

- Standard graphic height (approx) 2225mm
- 3 x 3 or 3 x 4 curved frames, supplied with mag bars, hangers and kickers, and one 30m roll of magnetic tape
- Kit also includes a Zeus case and hinged thermoformed tabletop in beech plus 2 x Powerspot 950 halogen lights
- Zeus iPad table top option available

Graphic panel sizes (approx):
Front curved: 2225 (h) x 673 (w) mm
D-end panels: 2225 (h) x 673 (w) mm
Rear panels: 2225 (h) x 807(w) mm

Includes moulded case and table top



Basics Curved Double D Counter NEW

- 'Double D' shape with curved front edge and beech top and base
- Grey plastic tambour wrap
- Large sized table top
- Carry bags included



Basics Round Counter NEW

PK923

- Round counter from the Basics range with beech table top and base
- 450mm diameter, graphic can be made to required height up to 950mm high
- Carry bags included

Total hardware dimensions (approx):
Counter: 450 dia.
Wrap: 900 (h) x 1280 (w) mm



Watch video

Basics Range

Basics products include a wide range of banners plus hop-up and pop-up display systems all at great value for money.



Eco Flag

WD101

- Overall height 2.9m with plastic easy push-fit assembly
- 8 Litre capacity base
- White adjustable pole with white base

Visible graphic area (approx):
1800 (h) x 550 (w) mm

Total hardware dimensions (approx):
2940 (h) x 840 (w) mm
Base 350mm dia.



Basics Cafe Barrier

SP911 Post/SP-214-1500 Rail/ SP-913 Base



- Basics Café Barrier is a light version of the Deluxe Café Barrier system with posts and rails available in black or silver
- Use outdoor banner vinyl for your graphic panels
- Sold as individual components
- Suitable for indoor and outdoor use

*Printed graphic panels extra

Visual graphic area (approx)
1500mm - 675 (h) x 1350 (w) mm

Total hardware dimensions (approx):
Rail 1500mm
Post 950mm (h)
Base 350mm (dia.)



Post top in black



Black or silver base available



(Cannot be left outside in all weathers)

Basics Leader Rope & Pole



SP-911 Post/SP-907 Rope/SP-913 Base



Blue, black or red ropes with silver or gold clips

- Economy range of exhibition and event queue guidance system
- 1500mm rope available in black, blue or red with either connector or hooks in gold or silver
- Posts and bases available in gold or silver

Total hardware dimensions (approx):
Post 950mm (h)
Rope 1500mms
Base 350mm (dia.)

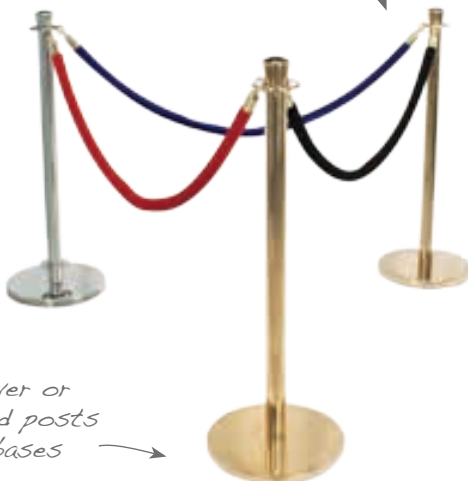

Basics Leader



SP-801 Post/SP-803 Belt/SP-913 Base

- Basics range for retractable barrier system, ideal for use in retail outlets and airports
- Posts available in black, gold or silver
- Retractable webbing available in black, grey or red

Total hardware dimensions (approx):
Post 910mm
Belt 2000mm
Base 350mm (dia.)



Retractable webbing cassette



Silver, gold or black posts & bases



POP-UPS & HOP-UPS

Lightweight, Compact, Practical

Pop-up and Hop-up display systems are quick and easy ways to provide creative back drops, exhibition stands and displays.

Both have clever frame systems that set up in minutes with graphics that are either easily attached to a Pop-up frame or left in place on a Hop-up.

Pop-ups

Pop-ups & Hop-ups

Pop-ups display systems are one of the quickest and simplest ways of creating effective back drops or exhibition stands. With a clever frame system that clicks together with ease your display is ready in minutes, complete your look with lights and a Pop-up counter or tower.



Evolution Xpress

EK101X/EK102X - EK501X/EK502X

- Self-locating 'smart' magnetic locking arms and low profile mag bars plus hangers
- Quality anodised aluminium frame and saffron components
- Available as frame or graphic kit single or double sided
- Choice of 3x1 to 3x5 quad systems either as free-standing, straight or curved



← Fully magnetic system

Evolution Quick

WH221/WH222/WH223/WH224/WH225

- Self-locating 'smart' magnetic locking arms and mag bars with adjustable clip-on graphic hanger fittings
- Available options as frame or graphic kit, single or double sided
- Choice of 3x1 to 3x5 quad systems either as free-standing, straight or curved



Powerspot 950 - PS950

Light options available, see page 97.



Clip on graphic panels



Graphic dimensions for Xpress and Quick

Quad combination	Visible graphic area (approx):	Total hardware dimensions (approx):
3x1	Curved 2019 (w) x 2225 (h) mm	2225(h) x 1240(w) x 306(d) mm
	Straight 2080 (w) x 2225 (h) mm	2225(h) x 1240(w) x 306(d) mm
3x2	Curved 2692 (w) x 2225 (h) mm	2225(h) x 1930(w) x 485(d) mm
	Straight 2814 (w) x 2225 (h) mm	2225(h) x 1970(w) x 306(d) mm
3x3	Curved 3365 (w) x 2225 (h) mm	2225(h) x 2540(w) x 685(d) mm
	Straight 3545 (w) x 2225 (h) mm	2225(h) x 2700(w) x 306(d) mm

Quad combination	Visible graphic area (approx):	Total hardware dimensions (approx):
3x4	Curved 4038 (w) x 2225 (h) mm	2225(h) x 3070(w) x 960(d) mm
	Straight 4278 (w) x 2225 (h) mm	2225(h) x 3435(w) x 306(d) mm
3x5	Curved 4711 (w) x 2225 (h) mm	
	Straight 5011 (w) x 2225 (h) mm	
4x5	Straight 5011 (w) x 2992 (h) mm	



Impact Bundle

3X3: 99-XX-071 3X4: 99-XX-070

- Standard graphic height (approx) 2225mm
- 3 x 3 or 3 x 4 curved frames, supplied with mag bars, hangers and kickers, and one 30m roll of magnetic tape
- Kit also includes a Zeus case and hinged thermoformed tabletop in beech plus 2 x Powerspot 950 halogen lights
- Zeus case included suitable for carrying both frame sizes and one set of graphics

Graphic panels (approx):
 Front curved: 2225 (h) x 673 (w) mm
 D-end panels: 2225 (h) x 673 (w) mm
 Rear panels: 2225 (h) x 807 (w) mm



Watch video



L Shaped Pop-up

WH223L/WH224L/WH225L

- Compact for easy storage with quality anodised finish
- Self-locating 'smart' magnetic locking arms and low profile mag bars
- Available in a combination of quad sizes from 3x3 to 3x5 free-standing exhibition displays

Total hardware dimensions (approx):
 2225 (h) x 1360/2215/2880 (w) x 2215 (d) mm

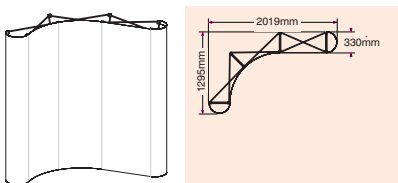

L Shaped Pop-up exhibit kit - 2.4m²

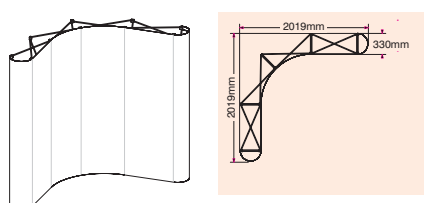

L Shaped Pop-up exhibit kit - 4m²

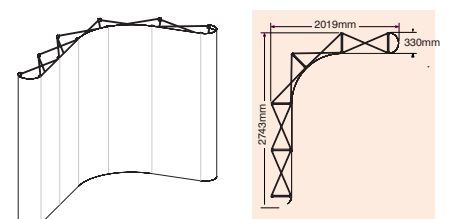

L Shaped Pop-up exhibit kit - 5.5m²

A convenient lightweight Pop-up counter that offers a substantial area to welcome your guests yet packs down for easy transportation in a wheeled trolley case.

Pop-up Counta

PUC21C-C/PUC22C-C

- Quick and simple self-locking magnetic assembly
- Thermoformed table top in beech effect with four internal shelves
- Supplied with reinforced D shaped wheeled trolley case

Visible graphic area (approx):
 2x1: 950mm (h) x 1540mm (w)
 2x2: 950mm (h) x 2060mm (w)

Total hardware dimensions (approx):
 2x1: 985mm (h) x 865mm (w) x 400mm (d)
 2x2: 985mm (h) x 1290mm (w) x 465mm (d)



Reinforced D shaped wheeled trolley case



Pop-up counta 2x1



Pop-up counta 2x2



Desktop Pop-up 2x2

WH240-C-C

- Stylish table top graphic
- Very quick to set up
- Collapses to a fraction of its full size making it easy to store and transport

Visible graphic area (approx):
 Total: 1219 (h) x 1930.4 (w) mm
 D-ends: 1219 (h) x 406 (w) mm
 Curved front: 1210 (h) x 558.8 (w) mm

Total hardware dimensions (approx):
 1219 (h) x 1466 (w) x 298 (d) mm



Quick Tower

WH231



- Round Pop-up tower
- Choice of heights up to four quads
- Linking cables for internal lights available and recommended
- Lights optional extra

Visible graphic area (approx):
 3 Quad: 2225 (h) x 2019 (w) mm
 4 Quad: 2968 (h) x 2019 (w) mm

Total hardware dimensions (approx):
 2265 (h) x 640mm diameter
 Based on 3 quad

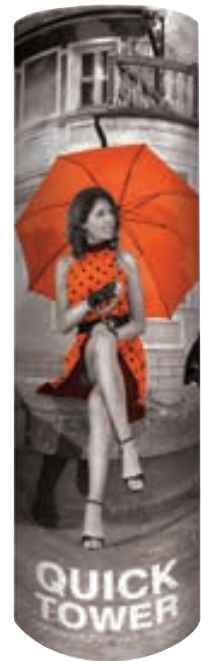

Accessories

Pop-up monitor bracket PUSMK1

Add audio visual to your stand.



Pop-up shelving

For curved and straight systems.



Stabilising feet

Recommended for straight systems or where internal or external load-bearing shelving is used. Available for Hop-ups and Pop-ups.



Pop-up fabric

- Hard wearing fabric panels
- Use plain or add graphics with hook fastener
- Available for any brand of Pop-up system



D-end Pop-up lighting PS1200

Illuminate with 20w fluorescent lighting for greater display impact.



Graphic cases

The essential accessory to transport Pop-ups.

1200mm: AC332
 900mm: AC333



Case to counter conversion

Ellipse Plus and Zeus Pop-up cases may be converted into counters, with a table top and a choice of fabric wraps. iPad table top option available, see page 89.



Hop-ups Pop-ups & Hop-ups

Lightweight and portable, Hop-up displays offer an easy and quick method for display systems. With fabric graphics that can be left in place you simply extend the framework, and click it into place and you're ready to go.



Impact Hop-up

HUI3X2/HUI3X3/HUI3X4/HUI3X5

NEW

- Fabric fits smoothly across the frame work and stays in place once the frame has been collapsed
- Lightweight Hop-up system that's very quick and easy to set up
- Single sided with yellow locking arms

Visible graphic area (approx):
 3x2 - 2262 (h) x 2222 (w) mm
 3x3 - 2262 (h) x 2960 (w) mm
 3x4 - 2262 (h) x 3698 (w) mm
 3x5 - 2262 (h) x 4436 (w) mm

Total hardware dimensions (approx):
 2260 (h) x 1525/2260/2995/3730 (w)
 x 295 (d) mm



Recommend optional feet for stability, see page 48. →



Light options available, see page 97.



Hop-up Counta

HU301-001-C

NEW

- Quick and easy to assemble with single wrap around fabric graphic
- Tool free assembly
- Single shelf and carry bag included

Visible graphic area (approx):
 995 (h) x 1685 (w) mm

Total hardware dimensions (approx):
 1020mm (h) x 1065mm (w) x 400mm (d)



SEG Counter

PUC21C-SEG

NEW

- Display counter with thermoformed top in choice of five colours
- Two shelves for storage
- Optional fabric graphic wrap that fits easily and snugly into the silicone edged channel

Visible graphic area (approx):
 937 (h) x 2340 (w) mm

Total hardware dimensions (approx):
 985 (h) x 840 (w) x 360 (d) mm



Fitting graphics into SEG channel



Modular Display Stands Pop-ups & Hop-ups

Create exciting and effective modular display stands using Pop-up technology. Quick, easy and very cost effective.



Pop-up systems are a cost effective and efficient way to create a range of display stands for exhibitions and presentations.

Create straight or curved panels, add towers, shelving and cupboards, complete with lighting and counters for a polished look at a great price.

With the clever Pop-up frame system using Neo magnetic locking arms, your stand can be assembled in minutes, snap graphics into place very quickly for a great looking stand.

Use optional graphic cases to store and transport your frame and graphics, you can even convert your case into a counter with shelves and graphic wrap to use whilst on the stand.



3D
designservice

Using the latest CAD software technology, our experienced 3D design team will work with you to design and then render your exhibition display stand so you can view before you buy.





Standard display system

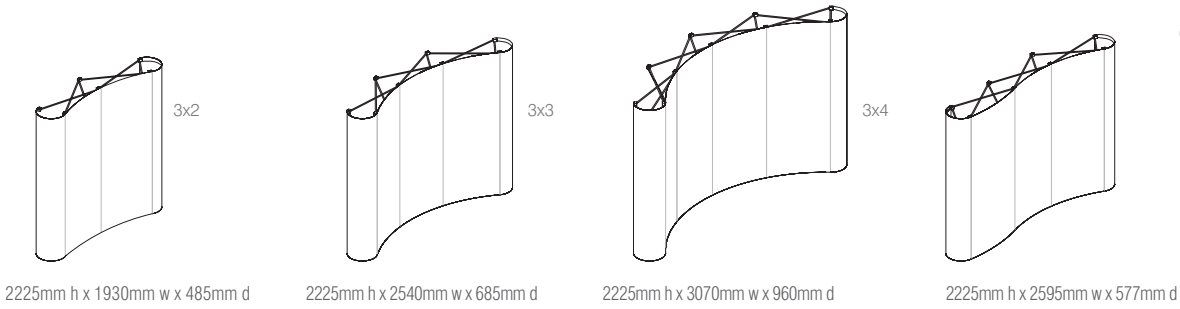

Floor standing

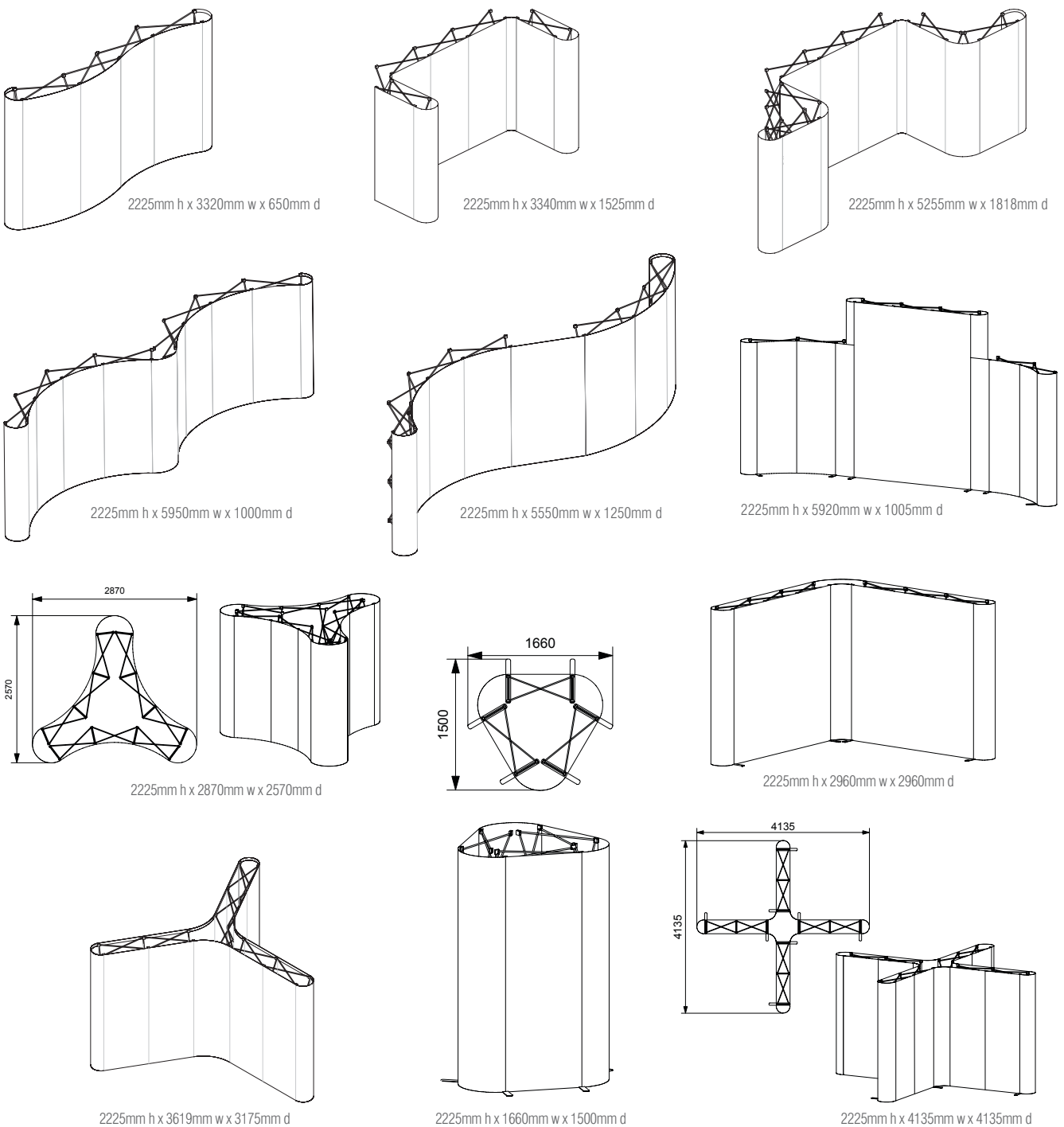



EXHIBITION & PORTABLE MARKETING KITS

Portable, Engage, Reuse

Construct exhibition and marketing display solutions using a range of different materials to create different looks and textures.

Formulate, Vector, Linear and Arena offer standard kits that can be assembled quickly and easily with your own graphics.

Formulate

Formulate back walls are aluminium structures with textile fabric graphic socks that wrap snugly around each frame. Graphics can be removed and replaced easily, perfect for when your message needs changing often. Choose from four shapes.



Formulate Table Top

FMLT-TT-C

Total hardware dimensions (approx):
1140 (h) x 1575 (w) mm



For more information on our folding tables and table cloths see page 79

Formulate Vertical Curve

FMLT-WV10-C

Total hardware dimensions (approx):
2310 (h) x 2900 (w) mm



Formulate Straight

FMLT-WS10-C

Total hardware dimensions (approx):
2340 (h) x 2900 (w) mm



Formulate Horizontal Curve

FMLT-WH10-C

Total hardware dimensions (approx):
2340 (h) x 2870 (w) mm

Optional lighting available, see page 97



Add dimension and excitement to your Formulate back walls with some 'funky shapes' that attach to the front of the frame.

Choose from three designs complete with printed graphic fabric sock.



Formulate Angled

FMLT-FSP

Can be placed angled to the right or to the left

Total hardware dimensions (approx):
2350 (h) x 1450 (w) mm



Formulate Trapezium

FMLT-FST

Can be attached either way up depending on your design

Total hardware dimensions (approx):
2350 (h) x 1570 (w) mm



Accessories available

Formulate Curved Ladder

FMLT-FSL

Versatile shape, add more than one ladder for extra effect

Total hardware dimensions (approx):
2330 (h) x 755 (w) mm



Linear Vector Kits

Linear Vector is a lightweight, double-sided aluminium modular system designed to create a wide variety of frameless and seamless displays. Choose from a range of double sided free standing modular kits.



Kit 1

VKF-H4-SL for fabric
VKR-H4-SL for rigid substrate

Visible graphic area (approx):
2000 (h) x 1000 (w) mm

Total hardware dimensions (approx):
2070 (h) x 1000 (w) x 450 (d) mm

Optional Linear Vector Kit Feet



Side foot

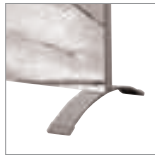

Arched foot



Flat foot



Quarter side foot.
Allows panels to fit flush against the wall with extra stability.



Kit 1 - x 1, 2000mm (h) x 1000mm (w) frame 1 pair of feet

Kit 2

VKF-2H4-2SL for fabric
VKR-2H4-2SL for rigid substrate

Visible graphic area (approx):
2000 (h) x 2000 (w) mm

Total hardware dimensions (approx):
2070 (h) x 2000 (w) x 450 (d) mm



Kit 2 - x 2, 2000mm (h) x 1000mm (w) frame 2 pairs of feet



Kit 3

VKF-3H4-2SL for fabric
VKR-3H4-2SL for rigid substrate

Visible graphic area (approx):
2000 (h) x 3000 (w) mm

Total hardware dimensions (approx):
2070 (h) x 3000 (w) x 450 (d) mm



Kit 3 - x 3, 2000mm (h) x 1000mm (w) frame 2 pairs of feet

Kit 4

VKF-3H4-2P for fabric
VKR-3H4-2P for rigid substrate

Visible graphic area (approx):
2000 (h) x 3000 (w) mm

Total hardware dimensions (approx):
2070 (h) x 3000 (w) x 450 (d) mm

Optional iPad holder available



Kit 4 - x 3, x 2000mm (h) x 1000mm (w) frames x 2, 2000mm (h) Linear posts

Kit 5

VKF-5H4-2P for fabric
VKR-5H4-2P for rigid substrate

Visible graphic area (approx):
2000 (h) x 5000 (w) mm

Total hardware dimensions (approx):
2000 (h) x 3100 (w) x 1050 (d) mm



Kit 6

VKF-4H4-2H2-3P for fabric
VKR-4H4-2H2-3P for rigid substrate

Visible graphic area (approx):
2000 (h) x 5000 (w) mm

Total hardware dimensions (approx):
2000 (h) x 4150 (w) x 550 (d) mm



Kit 7

VKF-2H8-2H2-3P for fabric
VKR-2H8-2H2-3P for rigid substrate

Total hardware dimensions (approx):
2000 (h) x 4950 (w) x 550 (d) mm



Lights, monitors, LCD brackets and poser tables shown are all Vector accessories and not included. See page 61 for optional accessories.

Linear Kits

Linear Executive kits and panel kits can deliver displays with real style and impact. Ideal for semi-permanent displays for showrooms, shopping centres and exhibitions venues. Enhance your kit with Linear accessories that fit easily into the Linear channel.



Executive Wave

LK031-001/2/3

Visible graphic area (approx):
2000 (h) x 2000 (w) mm

Total hardware dimensions (approx):
2475 (h) x 3000 (w) x 500 (d)

- 2 LCD mounts & 4 shelves LK031-001
- 2 LCD mounts & 4 literature holders LK031-002
- 6 literature holders LK031-003



TV monitors are not included

LK031-001 - Exec Wave with 2 LCD mounts & 4 shelves

Executive Curve

LK030-001/2/3

Visible graphic area (approx):
2000 (h) x 2000 (w) mm

Total hardware dimensions (approx):
2475 (h) x 3000 (w) x 500 (d)

- 2 LCD mounts & 4 shelves LK030-001
- 2 LCD mounts & 4 literature holders LK030-002
- 6 literature holders LK030-003



LK030-003 - Exec Curve with 6 literature holders



LCD Graphic Panel kit

LK025-C to E

Total hardware dimensions (approx):
C 2000 (h) x 1000 (w) mm*
D 2000 (h) x 2000 (w) mm
E 2000 (h) x 3000 (w) mm

2000 (h) x 1000 (w) mm* units shown



Monitor up to 20" approx

TV monitors are not included



Straight Wire Panel kit

LK022-B to D

Visible graphic area and total hardware dimensions (approx):
B 2000 (h) x 500 (w) mm
C 2000 (h) x 1000 (w) mm*
D 2000 (h) x 2000 (w) mm

2000 (h) x 1000 (w) mm* unit shown



Curved Graphic Panel kit A

LK023-C to E

Visible graphic area and total hardware dimensions (approx):
 C 2000 (h) x 1000 (w) mm*
 D 2000 x (h) x 2000 (w) mm
 E 2000 x (h) 3000 (w) mm

2000 (h) x 1000 (w) mm* unit shown



Optional iPad holder available

iPad not included

Straight Graphic Panel kit A

LK020-B to E

Visible graphic area and total hardware dimensions (approx):
 B 2000 (h) x 500 (w) mm
 C 2000 (h) x 1000 (w) mm*
 D 2000 (h) x 2000 (w) mm
 E 2000 (h) x 3000 (w) mm

2000 (h) x 1000 (w) mm* unit shown



Straight Graphic Panel kit B

LK021-B to E

Visible graphic area and total hardware dimensions (approx):
 B 2000 (h) x 500 (w) mm
 C 2000 (h) x 1000 (w) mm*
 D 2000 (h) x 2000 (w) mm
 E 2000 (h) x 3000 (w) mm

2000 (h) x 1000 (w) mm* unit shown



Curved Graphic Panel kit B

LK024-B to D

Visible graphic area and total hardware dimensions (approx):
 C 2000 (h) x 1000 (w) mm
 D 2000 (h) x 2000 (w) mm
 E 2000 (h) x 3000 (w) mm

2000 (h) x 3000 (w) mm* unit shown



For Linear literature post solutions please see page 71



TV monitors and iPad not included

Please note:

LCDs, lights and graphics shown are for illustration purposes only and are not included with the kits. Measurements show maximum recommended graphic area. This will vary depending on which fixing option is used.

For recommended graphic areas for each of the graphic fixing options, please refer to the data sheet for each individual kit.

Linear Counters & Columns

Create modern and stylish displays with Linear Columns and Counters. Add slat walls, shelving and graphic panels to customise your own design.



Retail Linear Column

LNC-RLC-F0 Frame only



With a Linear Column you have a multitude of options to create versatile retail display units.

- Add graphics, lightbox or banner to customise column
- Attach LCD monitor bracket or iPad holder

Total hardware dimensions (approx):
1000mm high x 1450mm x 450mm wide



Frame only - LNC-RLC-F0



Optional iPad holder
LNC-RLC-SH

Shelf (1 shelf)
LNC-RLC-SH

Slat wall panel
LNC-RLC-SW

Customise your column



Lightbox kit
(Half) LNC-RLC-HLK
(Full) LNC-RLC-FLK

For more Linear columns see page 78

Linear Curved Counter

Standard LK028-001/003 Pro LK028-002/004

- Finished with 3-5 mm thick PVC foamed board graphics*
- Available in 30° and 45° radius
- Standard unit without top shelf
- Optional internal shelf available on request

Visible graphic area (approx):
30°: Front Panel 949 (h) x 907 (w) mm
30°: Side Panels 949 (h) x 376 (w) mm
45°: Front Panel 949 (h) x 1426 (w) mm
45°: Side Panels 949 (h) x 425 (w) mm

Total hardware dimensions (approx):
30°: 1010 (h) x 1025 (w) x 546 (d) mm
45°: 1010 (h) x 1515 (w) x 607 (d) mm

*Graphics are for illustration only and are not included.

Acrylic top shelf with stand-offs available on Pro version



Linear Straight Counter

LK029-001/ LK029-002

- Finished with 3-5 mm thick PVC foamed board graphics*
- Available in 1000mm and 2000mm widths

Visible graphic area (approx):
LK029-001 Front Panel 949 (h) x 880 (w) mm
LK029-001 Side Panels 949 (h) x 380 (w) mm
LK029-002 Front Panel 949 (h) x 1880 (w) mm
LK029-002 Side Panels 949 (h) x 380 (w) mm

Total hardware dimensions (approx):
1010 (h) x 1000 (w) x 500 (d) mm

*Graphics are for illustration only and are not included.



Linear Lite Counter

LK038

- Finished with PVC graphics* fixed using steel and mag tape making it lightweight and easy to transport
- Suitable for 440-550 micron pop-up PVC graphics

Visible graphic area (approx):
Front Panel 1000 (h) x 798 (w) mm
Side Panels 1000 (h) x 230 (w) mm

Total hardware dimensions (approx):
1040 (h) x 915 (w) x 405 (d) mm

*Graphics are for illustration only and are not included.



Linear Lozenge

LK039



- Very stylish counter
- Can have shelf options
- Tops available in five colour options
- Magnetic graphics attach to underside

Total hardware dimensions (approx):
1000 (h) x 1450 (w) x 450 (d) mm



Arena4 Gantry

The Arena4 Gantry system is ideal for creating exciting exhibition stands, showroom and retail displays with a wide variety of components for complete design flexibility.



- Lightweight aluminium construction
- Quick and easy to assemble with bolt and wing nut fixings - no tools required
- Load bearing up to 100kgs over 2m span.
- Maximum unsupported span of 6m
- Outer dimensions of quad 200 x 200 mm approx
- 25 mm approx tube dimensions

Accessories shown are not included

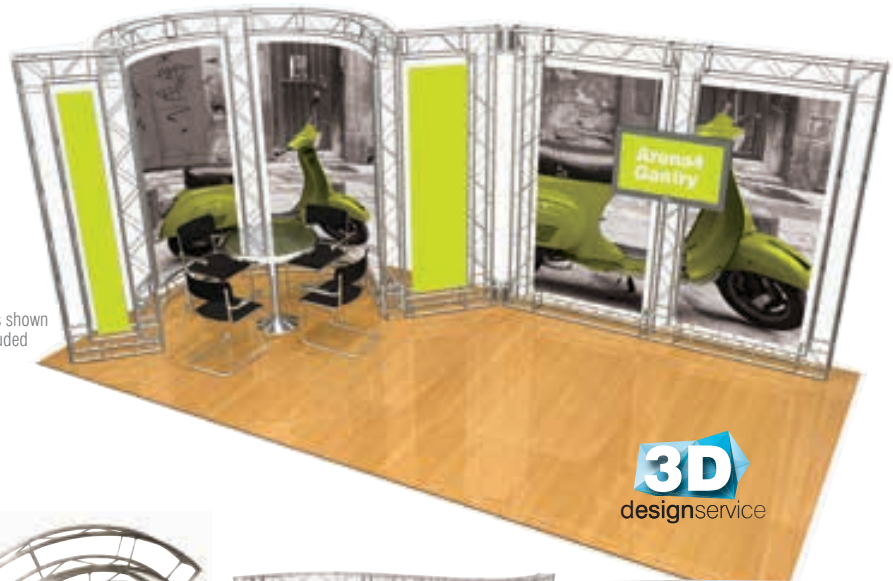

3D
designservice



Straight Section available in 9 lengths: 250, 300, 500, 750, 1000, 1250, 1500, 1750 & 2000mm (add UT-S before each length for the code)

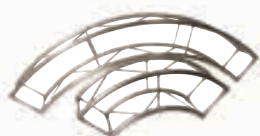

Radius Curved
1000 - UT-C1000
500 - UT-C500



Kit 1 - UT002



Kit 2 - UT001



Swivel Plate
UT-SP01



45° Angled Foot, shown with a 45° corner
UT-AF250

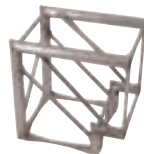

2 Way 90° Corner
UT-C21



Plasma Bracket
UT-LCD3 - up to 40kg approx.



LCD Bracket
UT-LCD1 - up to 15kg approx.

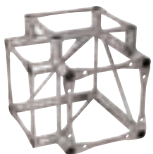

3 Way Corner Junction
UT-C30



4 Way Corner Junction
UT-C41



4 Way T Junction
UT-C40



Tabletops
Oval - TT400
Corner - TT400-1
Half Tabletop - TT400-2 (image shows 2 x TT400-2)
Available in five colours (Walnut, Black, Silver, Birch and White)



Literature Holder
TT401 - 10 pocket holder



250mm Base Section
UT-BS250

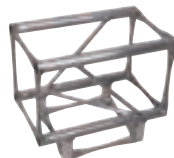

3 Way T Junction
UT-C35



5 Way Junction
UT-C55



250mm Hook Plate
UT-HP250

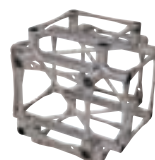

6 Way Junction
UT-C65

Linear & Linear Vector Accessories

Accessorise your Linear, Linear Vector or Arena Gantry stands with a wide range of products

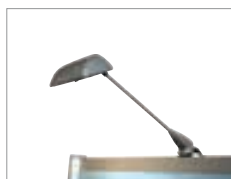

Powerspot 1000 PS1000 (use Linear fitting)



Powerspot 1060 LED Floodlight - PS1060S



LCD brackets 3 types available



NEW

iPad Holder 360° IPAD-360B/S/W See page 89



Compass graphic fixing LN502



Acrylic stacks



NEW

Fluorescent acrylic top caps - Available in red, green or blue and in three shapes.



Top caps



PVC wing extrusion LN608-1000



Engraved thermoformed top Custom item



NEW

UV printed table tops



Poser table LN319



Thermoformed base LN141



Oval base LN114-S



Linear Vector Flat foot



450mm steel dome base LN102



Aluminium literature holder LN112-C



Acrylic literature holder LN501



Slat-wall panel LN-SL-1000 x 750
Slat-wall leaflet holder (A4) AH310
Slat-wall hook AH321

Lights, monitors, LCD brackets and poser tables shown are all Linear Vector accessories and not included.

Posts



50mm round 4-way LN601



50mm 8-way LN618



50mm square 8-way LN616



75mm round 4-way LN602



75mm 8-way LN8W



75mm square 8-way LN607

Beams

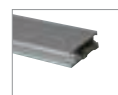

45mm LN605



50mm oval beam LN609



PANEL KITS

Adaptable, Re-configurable, Practical

Panel kits are a favourite display method, ideal for any training environment.

They are lightweight and portable with the added benefit of your graphics remaining in place. Choose from a varied range of panel kits to suit your requirement.

Baseline Range Panel Kits

Baseline offers table top, panel kits and aluminium edged kits all ideal for any training environment.



Baseline Panel Kit range

Baseline panel kits are lightweight and easy to transport even with graphics in situ.

There is a choice of Baseline, Baseline Plus with 25mm thick panels and new Baseline Aluminium.

All panels are finished in nylon fabric and available in a choice of thirty colours. Ideal for any training environment or display solution.

- Very popular hinged folding panel kits
- Quick and easy to assemble
- Choice of panel kits, junior and senior table top kits, jumbo panels and wheeled panel screens

Optional lighting available



Powerspot 50* PS050



Baseline 6 Panel Folding Kit

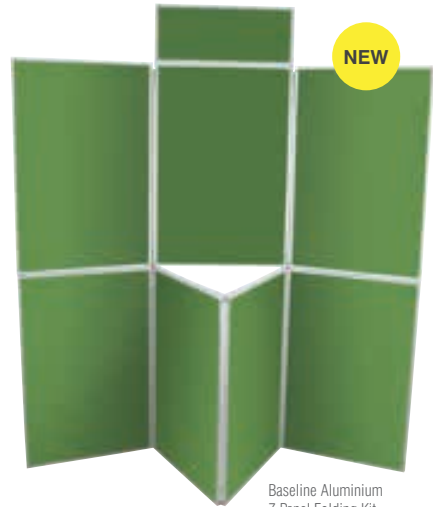

Baseline Aluminium 7 Panel Folding Kit

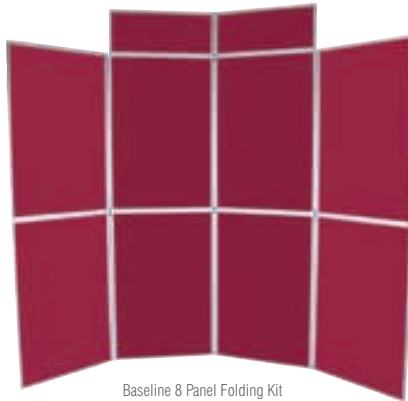

Baseline 8 Panel Folding Kit



Please note: We guarantee panels for use with hook and loop fasteners sold by us, which are specified as fit for purpose. We cannot guarantee panels against damage when other brands of hook and loop are used as they may have stronger hook adhesion, which carries the risk of damage and de-lamination to the panel fabric.

Baseline Junior and Senior table top kits

Junior kit - KK102/KK102A*
Senior kit - KK103/KK103A*
*A denotes aluminium trim

Baseline Tabletop Folding kits are lightweight and easy to transport, even with graphics in-situ. Panels are finished in nylon fabric, available in a choice of 30 colours.

- Choice of standard or luxury foam backed loop nylon fabrics
- Choice of black or grey frames
- Dry-wipe white board option available



Senior Kit



Junior Kit

Baseline Plus Panel Screens (Wheeled)

These panel systems are an ideal divider or display panel solution. With hinges and castors they are easily placed wherever required with a multiple choice of positions.



7 Panel Kit



*See page 97 for full range of lighting options

Baseline Plus and Aluminium Jumbo Panels

These jumbo panels are ideal for back walls and screens adding a degree of privacy with their 1.8m high walls.

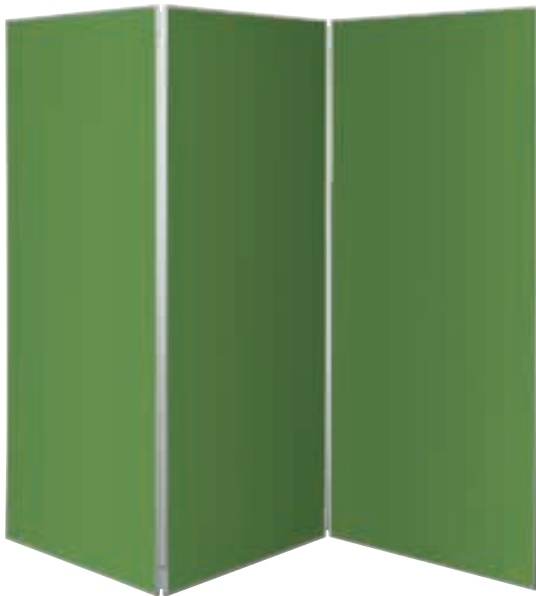

Panel kit size	Total hardware dimensions (approx):	Baseline Code	Baseline Plus Code	Baseline Aluminium Code
Panel Folding Kits				
6 Panel	900 (h) x 600 (w) mm 1000 (h) x 700 (w) mm	KK117 KK317	KKP117 KKP317	KK117A
7 Panel	900 (h) x 600 (w) mm 1000 (h) x 700 (w) mm	KK114 KK314	KKP114 KKP314	KK114A
8 Panel	900 (h) x 600 (w) mm 1000 (h) x 700 (w) mm	KK120 KK320	KKP120 KKP320	KK120A
Junior and Senior table top kits - Baseline and Aluminium only				
Junior Panels:	1 x 900 (h) x 600 (w) mm 2x 450 (h) x 600 (w) mm	KK102	-	KK102A
Junior Header:	250 (h) x 900 (w) mm	-	-	
Senior Panels:	3 x 900 (h) x 600 (w) mm	KK103	-	KK103A
Senior Header:	1 x 250 (h) x 600 (w) mm	-	-	
Panel Screens (wheeled) - Baseline Plus only				
5 Panel	1800 (h) x 600 (w) mm 1500 (h) x 600 (w) mm	-	KKPW5-186 KKPW5-156	-
6 Panel	1800 (h) x 600 (w) mm 1500 (h) x 600 (w) mm	-	KKPW6-186 KKPW6-156	-
7 Panel	1800 (h) x 600 (w) mm 1500 (h) x 600 (w) mm	-	KKPW7-186 KKPW7-156	-
Jumbo Panels - Baseline Plus and Aluminium only				
3 Panel	1800 (h) x 900 (w) mm	-	KKP350	KK350A
4 Panel	1800 (h) x 900 (w) mm	-	KKP351	KK351A

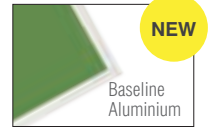
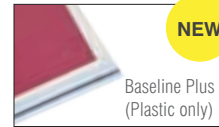
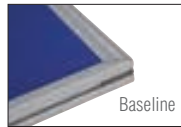

Flash Notice boards

Magnetic board - NB100-01/02
Non-magnetic board - NB101-01/02
Cork board - NB102-01/02
Felt board - NB103/NB104/NB105-01/02

- Cost effective range of quality notice boards, ideal for any training or work place environment
- Available in felt, non-magnetic, dry wipe, magnetic dry wipe or cork surfaces
- Supplied with satin anodised aluminium frame and fixings
- Flame retardant felt boards available in blue, red, grey or green

Total hardware dimensions (approx):
900 (h) x 600 (w) mm
1200 (h) x 9100 (w) mm

Great quality and great price!



Dry Wipe Boards come complete with pen shelf

Superflex, 'Green' Modular Solutions

Superflex provides an easy and effective way of creating displays and booths from foam-based display panels. Light, easy to assemble and convenient for storage. Ideal for displays, walling, pods and booths.

- Allows complete design flexibility
- Manufactured from high-impact white PVC
- Protects the edge of display boards to prevent damage
- No need for screws or fixings
- Use with 4 - 6mm substrates
- Extrusion length - 2.4m
- Reusable
- Available in packs of 10 only



Flexible - Ulex20 / Fixed 60 degree - Ulex19



Panel and Pole Panel Kits

Panel & Pole is a classic range of kits for practical, durable and reconfigurable displays. All kits are available in a choice of panel types and colours.



A practical, durable and adaptable framework for demonstration purposes.



No tools required, highly flexible

Baseline Panel & Pole Kits

- Quick and easy to assemble and reconfigure
- Choice of standard or luxury Foam Backed Loop Nylon fabrics
- Choice of black or grey frames
- Complete with 6 channel feet as standard
- Additional single panels available to extend the kit
- Optional circular bases available as an alternative to the channel feet
- Ideal to use as an exhibition display solution

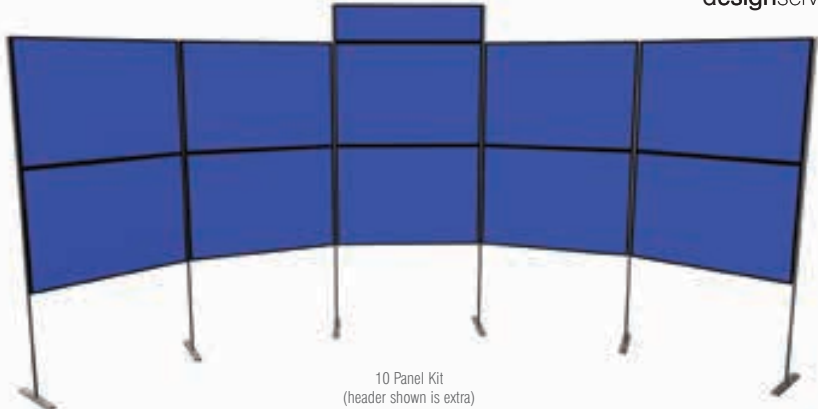

Optional 300mm (dia) base - LB913

Kit Type	Baseline	Baseline Plus	Aluminium	Phantom
900 x 600 mm				
4 panel	KK104	KKP104-96	KK104A	n/a
6 panel	KK106	KKP106-96	KK106A	n/a
8 panel	KK108	KKP108-96	KK108A	n/a
10 panel	KK110	KKP110-96	n/a	n/a
1000 x 700 mm				
6 panel	n/a	KKP106-107	n/a	KK132
8 panel	n/a	KKP108-107	n/a	KK134
10 panel	n/a	KKP110-107	n/a	KK136

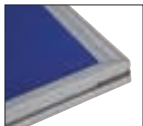

Baseline



Baseline Plus
(Plastic only)



Baseline Aluminium



Phantom
(Plastic only)

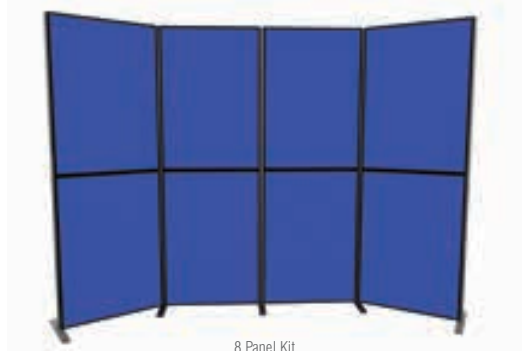
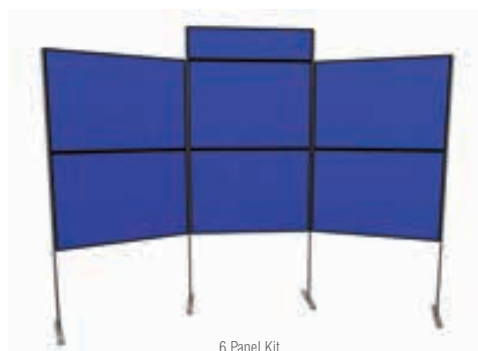

Phantom Panel Kits Panel Kits

Phantom panel kits are seamless, frameless panel and pole kits that connect together without requiring tools .



A highly reconfigurable, quick and easy stand display system. With a wide range of sizes and colours you can create stable modular display systems to suit your needs.

Phantom Panel Kits

- Great value panel kits using hook and loop to secure panels onto framework
- Can support flexible or rigid graphic panels
- Accessorise with lights, counters and table tops
- Buy as pre-configured kits or customise panels to suit your requirements

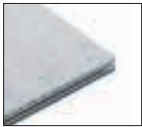

Phantom
(Plastic only)

NEW



10 Panel Kit
(Ten panels, three headers and one storage cupboard)



12 Panel Kit
(12 panels, four headers and two storage cupboards)



6 Panel Kit
(Six panels and one header)



6 Panel Kit
(Six panels, one header and one storage cupboard)

Gear Edge Panel Kits

Gear Edge panel kits and counters offer a stylish design with the added Gear Edge system that keeps your stand in exactly the position you require.



Gear Edge Panel Kits

GEP6/ GEP7/ GEP8

Gear Edge panel folding kits and counters are strong, robust and easy to transport, even with graphics in-situ. The durable aluminium gear edge frame system is suitable for permanent displays. Panels are available as frame only, or with a choice of fabric colours or with your own designed graphic infill panels, offering you the flexibility that best suits your requirements.

- Aluminium Gear Edge hinges allow the frame to be positioned at any angle
- Silver anodised frames are quick and easy to assemble
- Choice of three counter styles to complement your stand

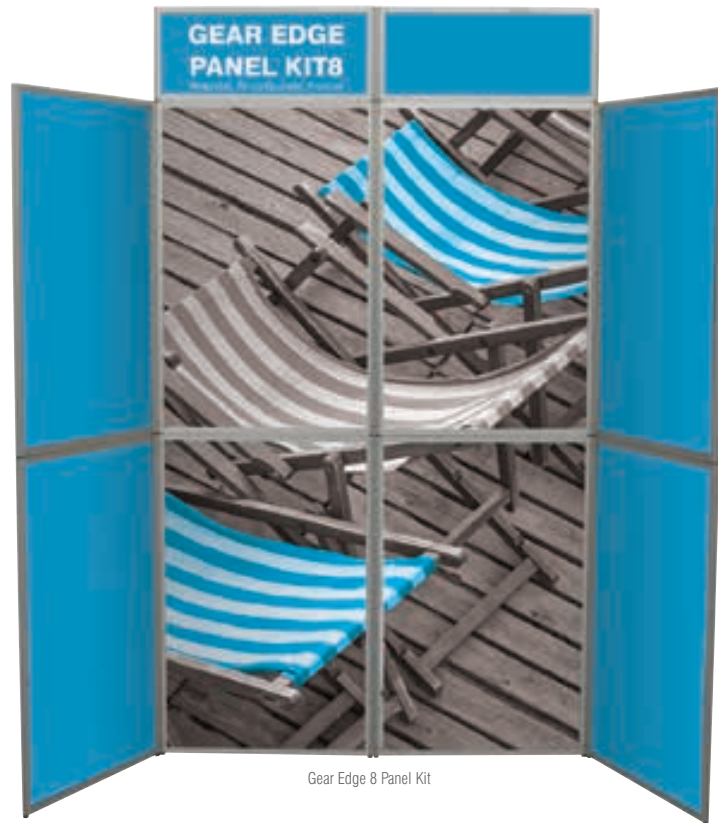

Gear Edge 8 Panel Kit



Gear Edge 6 Panel Kit



Gear Edge 7 Panel Kit

Panel kits	Visible graphic area (approx):	Code
6 Panel kit	867(h) x 556(w) mm	GEP6-96FO/FC
6 Header	217(h) x 556 (w) mm	
7 Panel kit	867(h) x 556 (w) mm	GEP7-96FO/FC
7 Header	217 (h) x 556 (w) mm	
8 Panel kit	867 (h) x 556 (w) mm	GEP8-96FO/FC
8 Header	217 (h) x 556 (w) mm x 2	

FO: Frame only / FC: Fabric covered

Total hardware dimensions (approx):

6 panel - 1500 (h) x 2050 (w) mm

7 panel - 2050 (h) x 1500 (w) mm

8 panel - 2050 (h) x 2100 (w) mm

Gear Edge Counters

GECS/GECC/GECD

Optional lockable cupboard door for extra security

Panel kits	Visible graphic area (approx):	Code
Straight front panel	867 (h) x 685 (w) mm	GECS-FO/FC
Straight side panel	867 (h) x 315 (w) mm	
Curve front panel:	867 (h) x 712 (w) mm	GECC-FO/FC
Curve side panel:	867 (h) x 315 (w) mm	
Display front panel:	622 (h) x 685 (w) mm	GECD-FO/FC
Display side panel:	622 (h) x 136 (w) mm	

FO: Frame only / FC: Fabric covered

Total hardware dimensions (approx):

Straight - 920 (h) x 830 (w) x 450 (d) mm

Curved - 920 (h) x 830 (w) x 525 (d) mm

Display - 920 (h) x 775 (w) x 405 (d) mm



Gear Edge Curved Counter



Gear Edge Straight Counter



Gear Edge Display Counter



LITERATURE HOLDERS

Convey, Excite, Inspire

Complete your display with a choice of stylish literature holders to suit any display situation.

Available in a range of materials including aluminium, polycarbonate, wood and even fabric.

Literature Holders

Literature holders are a must have accessory for your display. Practical and stylish, our range of holders are robust yet portable and pack down into carry bags or cases for easy transportation.



FIVE
YEAR

Popular range of aluminium literature stands that are stylish and extremely portable, ideal for exhibitions and displays.

Zed-Up Lite

AS315-002/AS318-002/AS319-002

- Hi-tech styling with A5, A4 and A3 capacity shelving in anodised silver and come complete with heavy duty hard case
- Six double sided acrylic shelves (seven for the A5 version) that fold down for easy transportation

Total hardware dimensions (approx):

Assembled:

A3 - 1420 (h) x 470 (w) x 370 (d) mm

A4 - 1460 (h) x 256 (w) x 370 (d) mm

A5 - 1300 (h) x 194 (w) x 284 (d) mm

Collapsed:

A3 - 110 (h) x 471 (w) x 400 (d) mm

A4 - 110 (h) x 256 (w) x 400 (d) mm

A5 - 120 (h) x 206 (w) x 284 (d) mm



Watch video



A3 - AS319



A4 - AS315-002



A5 - AS318

Cascade

AS320

- Lightweight polymer based literature holder with four pockets
- One-step cantilever assembly action for easy collapsing
- Transparent polycarbonate pockets that lock easily in an open or closed position
- Optional banner attachment allows a 600mm wide and up to 2000mm high graphic

Total hardware dimensions (approx):
 Assembled: 1480 (h) x 265 (w) x 310 (d) mm
 Collapsed: 360 (h) x 265 (w) x 310 (d) mm



NEW

Optional banner attachment available

10-Up Deluxe

AS205

- Neatly styled holder with 10 A4 'wire' frame pockets and smart matt silver finish
- Breaks into three pieces for easier transportation
- Slim and lightweight

Total hardware dimensions (approx):
 1365 (h) x 300 (w) x 360 (d) mm

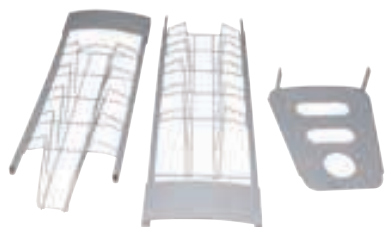

Aura

WH404

- Versatile one step cantilever literature stand, collapsible for easy transportation
- Four A4 pocket capacity with anti collapsible locking arm
- Attractive birch effect base, ideal for exhibition displays

Total hardware dimensions (approx):
 Assembled: 1400 (h) x 340 (w) x 310 (d) mm
 Collapsed: 360 (h) x 340 (w) x 310 (d) mm



Literature Holders

Literature holders are a must have accessory for your display. Practical and stylish, our range of holders are robust yet portable and pack down into carry bags or cases for easy transportation.



Zed-Up

WH412

- Highly functional, double sided holder with six pockets
- Collapsible for easy transportation
- Available in A4

Total hardware dimensions (approx):
 Assembled: 1540 (h) x 275 (w) x 365 (d) mm
 Collapsed: 195 (h) x 275 (w) x 365 (d) mm

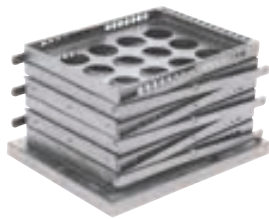

Acrylic literature holders

AH311/AH316/AH317

- Clear acrylic literature holders suitable for wall mounting or on desk top
- Standard fixing kit
- Available in A4, A5 or DL



DL - Desk or wall mounted AH311

A5 - Desk or wall mounted AH316

A4 - Desk or wall mounted AH317

Linear Media Posts

Graphic and literature post - LK026-001
 Audio visual and literature post - LK026-002
 Steel Literature holder LN112-C

Linear literature posts include a choice of audio, graphic and literature combinations to add to your stand.

Visual graphic area (approx):
 LK026-001 - 1800 (h) x 512.25 (w) mm
 LK026-002 - n/a

Total hardware dimensions (approx):
 LK026-001 - 2060 (h) x 523 (w) x 450 (d) mm
 LK026-002 - 1200 (h) x 500 (w) mm



Steel literature holder LN112-C

Graphic & Literature Post LK026-001



TV monitor not included

Audio Visual & Literature Post LK026-002



PORTABLE COUNTERS

Simple, Stylish, Versatile

Choose from a wide range of portable counters that are available for almost any situation or occasion.

Easy to assemble and extremely versatile with many able to support graphic wraps, portable counters are the perfect way to welcome your guests.

V Counter Portable Counters

Portable counters can be used for a variety of applications from welcoming guests to storing items to lecturns for presenting. Whatever your needs there is a counter to suit.



Robust, stylish counter or workstation with integral shelving and lockable storage. V Counter is available in two configurations - standard and deluxe with five finishes, you can also customise with an acrylic front panel using your own design.

Versatile and stylish counter in two configurations



Deluxe option includes integral shelf and lockable door

V Counter
PK30

- Two top shapes available, Keystone and Elipse.
- Unit available in black, white, birch, walnut or silver.
- Use optional fascia kit to customise with your own printed design
- No tool assembly and packs flat for easy storage and transportation.

Total hardware dimensions (approx):
 Elliptical: 1020 (h) x 950 (w) x 520 (d) mm
 Keystone: 1020 (h) x 900 (w) x 550 (d) mm

Optional iPad holder available, see page 89



Standard option with open back

Counter shown with Keystone top and acrylic fascia panel



LCD monitor and iPad not included

Physique Range

Physique offers the largest range of flat pack counters for portable marketing. Physique is available in two specifications to give the same end look one with fabric and one with graphic. We are able to manufacture any counter to your own specification.

MDF Freestyle –

Constructed using MDF tambour wraps and finished with a textile fabric covering. These counters have a load bearing weight of up to 75kg.

Physique Pole Graphic –

Constructed with a unique twist and lock aluminium pole system. Once the poles are in place they allow the application of your graphic direct to the unit.

There are three exceptions to Physique in the counter range: Lunar Lite which is a low cost lightweight counter option using a plastic tambour wrap – see page 75.

Physique Contour which is a professional hard-wearing PVC tambour based counter – see page 76.

Physique Tube Lite which is available in six standard shapes with 500/550 micron thickness wrap to give a lightweight support – see page 78.

Optional iPad holders available for most counters. Products come with a bag where marked. We can supply bags for all products as an optional extra.

Our furniture tops and bases are constructed from thermoformed MDF in a choice of five finishes and can have optional UV printing on any shaped table top.



Curved Double D

NEW

Optional UV printing on any table top

- 'Double D' shape with curved front edge and beech top and base
- Available in MDF Freestyle or Physique Pole graphic styles
- Large sized table top

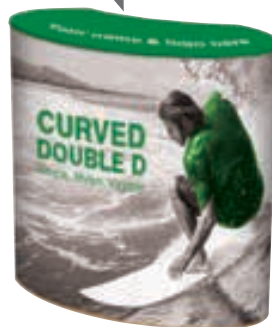

Physique Flag Kit

PKF001

NEW

- Add height and interest to your counter with a branded flag
- Flag kit can be fitted onto any counter table top



Flag sold separately to counter

Double D

PK161 /PT161

- Popular, strong and multi-purpose counter
- Generous sized table top
- Open back and full wrap options

Total hardware dimensions (approx):
 Counter: 1000 (h) x 1000 (w) x 500 (d) mm

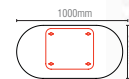

Comma

NEW

- Tear drop shaped counter available in MDF Freestyle or Physique Pole graphic styles
- Strong and sturdy design
- Open back



Crescent

PK187

- Simple half moon design ideal as greeting counter or product display unit
- Unit can be open or closed at the back
- Optional internal shelf available

Total hardware dimensions (approx):
 Counter: 1000 (h) x 950 (w) x 565 (d) mm
 Wrap: 970 (h) x 2425 (w) mm

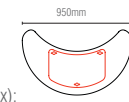

Physique Range

Portable Counters

Portable counters can be used for a variety of applications from welcoming guests to storing items to lecturns for presenting. Whatever your needs there is a counter to suit.



Eclipse

PK152/ PT152

- Ideal as a greeting counter, workstation or product display unit.
- Robust and offers storage
- Table tops available in birch, black, silver, white or walnut

Total hardware dimensions (approx):
Counter: 1000 (h) x 1000 (w) x 500 (d) mm
Wrap: 966 (h) x 2380 (w) mm



Saturn

PK188

- Stylish workstation or greeting counter
- Acrylic literature holder included
- Beech and aluminium tambour wraps also available

Total hardware dimensions (approx):
Counter: 1010 (h) x 850 (w) x 510 (d) mm
Wrap: 970 (h) x 1370 (w) mm



Lecturn

PK192/Pro:PK192P

- Stylish and portable counter, ideal for road shows and portable presentations.
- Available as a standard version without a shelf, or pro version where shelf is included
- Optional cable management port available

Total hardware dimensions (approx):
Counter 1000 (h) x 1000 (w) x 500 (d) mm
Wrap: 966 (h) x 2525 (w) mm



Comet

PK189/PK189A

- Stylish tear drop counter for when you need to grab attention
- Integral aluminium literature holder
- Optional aluminium flag post

Total hardware dimensions (approx):
Counter: 1010 (h) x 1010 (w) x 655 (d) mm
Wrap: 970 (h) x 1395 (w) mm



Mercury

PK190

- Multi-purpose counter unit with acrylic shelf and stand-offs
- Open or closed at the back with optional shelf
- LCD mount and cable management port included

Total hardware dimensions (approx):
Counter 1520 (h) (top of LCD post) x 850 (w) x 600 (d) mm
Wrap: 970 (h) x 2320 (w) mm



Luna

PK113-F/PK113-W

- Lightweight and very portable counter, ideal for road shows
- Low-profile shape with fine-grade fluted tambour for a smoother finish
- Twist and lock poles for added strength, integral shelf included

Total hardware dimensions (approx):
Counter: 1000 (h) x 860 (w) x 400 (d) mm
Wrap: 975 (h) x 1355 (w) mm



Cosmopolitan

MDF Freestyle: PK180 / Pole Graphic: PT180

- Versatile curved counter complete with a wire kit to suspend optional rigid graphics
- Eye catching and unusual promoter unit
- Graphic panel holders not included (RK306)

Total hardware dimensions (approx):
Counter: 1000 (h) x 1000 (w) x 450 (d) mm
Wrap: 966 (h) x 2340 (w) mm



Elan

PK182

- Stylish and distinctive styled counter
- Attractive wood detailing
- Generous table top area

Total hardware dimensions (approx):
Counter: 1000 (h) x 1000 (w) x 550 (d) mm
Wrap: 966 (h) x 2340 (w) mm



Urban

PK181

- Simple counter with a stylish and handy acrylic table top shelf and stand offs
- Designer look and feel
- Extremely portable and quick and easy to assemble

Total hardware dimensions (approx):
Counter: 1000 (h) x 1000 (w) x 500 (d) mm
Wrap: 966 (h) x 2380 (w) mm

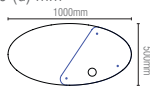

LCD monitor
not included



Data Pod

PK191/PK191P

- Compact pod designed to secure an LCD screen (included)
- Pro version comes complete with internal shelf
- Ideal as an information or demonstration point

Total hardware dimensions (approx):
Counter: 1610 (h) x 650 (w) x 600 (d) mm
Wrap: 1059 (h) x 1740 (w) mm
Including internal shelf: 840 (h) x 1740 (w) mm

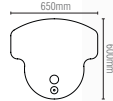

LCD monitor
not included



Physique Header Kit

PKH001

- Header made from 3mm white foam board
- 1m high steel poles
- Poles come complete with fixings and template
- Header kit can be fitted onto any counter table top
- Printing options available

Add height and visibility to your counter

NEW



Header sold separately to counter

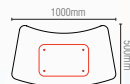

Curved Workstation

MDF Freestyle: PK160 / Pole Graphic: PT160

- Simple, yet versatile curved counter which can have an open or closed back
- Available in Physique Freestyle or Graphic units
- Choice of luxury foam backed loop nylon or smooth fabric wraps

Total hardware dimensions (approx):
Counter: 1000 (h) x 1000 (w) x 500 (d) mm
Wrap: 966 (h) x 2770 (w) mm



Physique Contour

PK501/PK502/PK503/PK505

A range of four exciting designs that are strong, durable, high specification counter units specially created to complement the latest stand designs. Available as pro kit with shelf included and standard without shelf. Heavy duty Physique constructed from MDF thermoformed tops with plinths and stand-offs. Available in a choice of finishes. Flexible PVC tambour wraps available in white or silver.

iPad holders
available on most
counters



Standard Kit (no internal shelf or second tier)

Pro Kit includes shelf & second tier (sliding door shown is an optional extra)



Pebble - PK503-S1 (Standard)
PK503S (Pro)

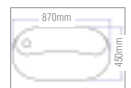

Circuit - PK501-S1 (Standard)
PK501S (Pro)



Island - PK502-S1 (Standard)
PK502S (Pro)

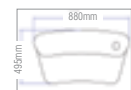

Keystone - PK505-S1 (Standard)
PK505S (Pro)

Total hardware dimensions (approx):

Standard Units	Keystone	915 (h) x 880 (w) x 495 (d) mm
	Circuit	915 (h) x 870 (w) x 450 (d) mm
	Island	915 (h) x 900 (w) x 528 (d) mm
Pro Units	Pebble	915 (h) x 900 (w) x 585 (d) mm
	Keystone	1060 (h) x 880 (w) x 495 (d) mm
	Circuit	1060 (h) x 870 (w) x 450 (d) mm
Main wrap	Island	1060 (h) x 900 (w) x 528 (d) mm
	Pebble	1060 (h) x 900 (w) x 585 (d) mm
	Optional door wrap	900 (h) x 558 (w) mm

Plinths and Towers

Portable Counters

Portable counters can be used for a variety of applications from welcoming guests to storing items to lecturns for presenting. Whatever your needs there is a counter to suit.



Spiral Display Tower

Tower: UB710-002

Portable aluminium collapsible display system available as a tower or counter, no tools necessary, simply pull up and twist to lock into place, afterwards it fits neatly into a single wheeled case.

Ideal for custom branding by replacing the acetate panels provided with your own graphics.

iPad table top holder available.

Total hardware dimensions (approx):
Tower: 2065 (h) x 565 (dia) mm



Spiral Plinth

Plinth: UB710 / with iPad holder add UE-177

- Available as a table top unit in silver, black or white surround
- Thermoformed table top available in walnut, white, black, silver or birch
- Optional secure flush mounted iPad holder for the Spiral display system

iPad not included

Total hardware dimensions (approx):
Plinth: 1070 (h) x 580 (dia) mm



Plinth only: UB710

Shown with optional iPad holder



Plinth with iPad holder: UB710 & UE-177

Round Display Plinths

PK115/PK118/PK121/PK127

- Range of flat packed plinths for displaying items
- Freestyle or Graphic options
- Choice of fabric colours and table tops

Visible graphic area (approx):
366 (h) x 1190 (w) mm
766 (h) x 1190 (w) mm
966 (h) x 1845 (w) mm
1166 (h) x 1190 (w) mm

Total hardware dimensions (approx):
400 (h) x 400(w) mm
800 (h) x 400 (w) mm
1000 (h) x 600 (w) mm
1200 (h) x 400 (w) mm



Multi-height Nest Plinths

PK129/PK131/PK133

- Multi-height circular display plinths are part of the Physique Freestyle flat-pack portable furniture range; ideal for product display.
- No tools required enabling quick assembly, the plinths are flat packed and easy to transport
- Choice of fabric colours and table tops

Total hardware dimensions (approx):
1200/800/400 (h) x 400(w) mm
1000/800/600 (h) x 600 (w) mm
1000/800/600 (h) x 750 (w) mm

Optional UV printing on any table tops

NEW



Physique Tube Lite

Hardware only: PK119-E Elipse/Double D Tops
 PK119-R Round, Propeller, Square or Pentagon
 Hardware and fabric wrap: PK119-EF

- Choose from six table top shapes and a choice of finishes
- Suitable for PVC or fabric wrap using a specially designed joining strip
- Quick and easy to assemble

Visible graphic area and total hardware dimensions (approx): Variable

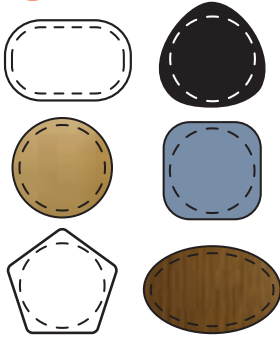

Six table top shapes come in a choice of finishes



Lecturn Linear Column

LNC-LEFO Frame only

- Smart, sleek looking lecturn style counter made from aluminium posts and MDF table top in a choice of five colours
- Attractive acrylic surface shelf supported with stand-offs
- Internal shelf with optional graphic panel to the front

Visible graphic area (approx):
 885 (h) x 525 (w) mm graphic panel

Total hardware dimensions (approx):
 1015 (h) x 640 (w) x 325 (d) mm



Internal shelf included

Standard Linear Column

LNC-STFO Frame only / LNC-STLB Light box

- Standard sized counter with option to have printed graphic panels
- Optional iPad holder 360° for multi media solutions
- Lightbox version comes with white panels, optional printing available
- Internal LED lighting options of white or RGB

Visible graphic area (approx):
 970 (h) x 525 (w) mm graphic panel

Total hardware dimensions (approx):
 1010 (h) x 640 (w) x 325 (d) mm



Slim Linear Column

LNC-SLFO Frame only / LNC-SLLB Light box

- Slim sized counter with option to have graphic panel front and back
- Made from aluminium posts with a choice of five MDF table top colours
- Lightbox version comes with white panels, optional printing available
- Internal LED lighting options of white or RGB

Visible graphic area (approx):
 970 (h) x 280 (w) mm graphic panel

Total hardware dimensions (approx):
 1010 (h) x 380 (w) x 245 (d) mm



Indoor/Outdoor Portable Counters

Choose from two specially designed counters for outdoor usage, with base and header units for extra graphic display options



Tornado

PK410

- Lightweight, weather proof and durable curved outdoor/indoor counter with tambour graphic wrap
- Support poles and header panel for extra visibility
- Moulded top has pen recess and water drainage notches, hollow base can be weighted with water or sand for outdoor usage

*Header and support poles optional extra (PK411)

Visible graphic area (approx):
Base: 872 (h) x 950 (w) mm
Top: 250 (h) x 675 (w) mm

Total hardware dimensions (approx):
1040 (h) x 850 (w) x 500 (d) mm
PVC wrap: 900 (h) x 2070 (w) mm
Header: 250 (h) x 600 (w) mm



Counta

PC607

- Cost effective indoor/outdoor demonstrator made of lightweight plastic, portable and simple to assemble
- Apply graphics as vinyl or screen print directly onto the plastic base wrap
- Includes rigid header panel, shelf and twin supporting poles. *Additional weights required for outdoor use

Visible graphic area (approx):
Base: 770 (h) x 816 (w) mm
Header: 280 (h) x 770 (w) mm

Total hardware dimensions (approx):
Base: 850 (h) x 810 (w) x 470 (w) mm
Header: 285 (h) x 775 (w) mm



Folding Table and Exhibition Cloths

FT-6

- Polypropylene and metal frame trestle table with folding legs
- Folds in half with carry handles for easy transportation
- Strong and sturdy can be used for many situations and applications
- Complete your look with a custom table cloth in display polyester printed with your design

Total hardware dimensions (approx):
Open: 730 (h) x 1830 (w) x 1220 (d) mm
Folded: 920 (h) x 1220 (w) x 90 (d) mm



Cube Seats

PS-453

NEW

- Made from lightweight polystyrene, offering comfortable seating option
- Stylish, modern and easily transportable
- Can be supplied with or without textile fabric cover

Total hardware dimensions (approx):
450 (h) x 450 (w) x 450 (d) mm





SIGNAGE SYSTEMS

Inform, Bold, Define

Catch the attention of passers-by with a varied range of professional signage systems.

Choose from a wide range of products including outdoor sign boards, wall frames and poster frames plus much more.

Sign Boards Signage Systems

A choice of sign boards including, swing sign, A-Frame and free standing all suitable for outdoor or indoor use

ONE
YEAR

Whirlwind

UB207

- Heavy-duty double sided outdoor swing sign that is ideal for pavement advertising and retail promotions
- Wheeled compact moulded hollow base for water or sand weighting
- Spring pivot for swing motion and packs flat for easy transportation

Visible graphic area (approx):
A1 - 820 (h) x 575 (w) mm

Total hardware dimensions (approx):
1165 (h) x 780 (w) x 500 (d) mm



A-Sign Board

VF204-C/VF204-A2

- Double-sided snap frame suitable for A1 and A2 size posters
- New B1 and B2 sizes available soon
- Easy front loading
- Galvanised steel backing adding extra strength and stability

Visible graphic area (approx):
A1 831 (h) x 584 (w) mm
A2 594 (h) x 420 (w) mm

Total hardware dimensions (approx):
A1 1060 (h) x 638 (w) x 825 (d) mm
A2 925 (h) x 465 (w) x 675 (d) mm



Wooden A Board

VF201

NEW

- Attractive wooden chalk board, ideal pavement sign for use outside pubs and restaurants
- Frame made from strong wood with chalk board area. Use special liquid chalk pens for your message
- Rubber feet, chrome hinges and tensioning chain

*Liquid chalk pens optional extra

Visible graphic area (approx):
672 (h) x 473 (w) mm

Total hardware dimensions (approx):
850 (h) x 550 (w) mm



Chaser

UB113

NEW

- Double sided display unit
- Stylish powder-coated oval tubular frame and black recycled PVC base with excellent stability
- Gloss white aluminium panel for vinyl graphics or direct printing
- Spare blanks available

Visible graphic area (approx):
789 (h) x 519 (w) mm

Total hardware dimensions (approx):
959 (h) x 590 (w) x 407 (d) mm



For more sign boards see page 34-35

Projecting sign

SP-PJL-200/300

- A wall mounted signage system for use in any type of workplace
- Smart and modern looking, finished in grey anodised aluminium
- Comes complete with hard-wearing plastic wall fixing plate and end cap

Total hardware dimensions (approx):
 300mm: 280 (h) x 90 (w) max mm
 200mm: 180 (h) x 90 (w) max mm



Sentry

SL103/SL104

- Snap action free-standing poster frame for information display use
- Head rotates for either portrait or landscape format literature
- Available in A4 and A3 sizes in aluminium with anodised silver finish

Total hardware dimensions (approx):
 A4 Total: 1005 (h) x 245 (w) x 326 (d) mm
 A4 Frame only: 277 (h) x 190 (w) mm
 A3 Total: 1075 (h) x 245 (w) x 326 (d) mm
 A3 Frame only: 398 (h) x 278 (w) mm

FIVE YEAR



Shield

UB108 with panel/UB108B base only

NEW

- Ideal pavement advertiser, can be used indoors and out
- Rigid sign board with hard recycled rubber base complete with securing bolts
- Comes complete with two blank shapes
- Print your message onto the pre-stamped aluminium sheet using self-adhesive transfers or UV flat bed print

Visible graphic area (approx):
 800 (h) x 410 (w) x 1.2 (d) mm

Total hardware dimensions (approx):
 800 (h) x 465 (w) x 450 (d) mm



Streamline Poster Frame

SP-SL-A6-A1

NEW

- Simple to use slim-line poster frame made from lightweight aluminium with an acetate front sheet and high impact polystyrene backing sheet
- Available in sizes A6 to A1
- Suction cup system for easy removal of the acetate sheet

Standard frame sizes (approx):
 A6 108m (h) x 151 (w) x 6.5 (d) mm
 A5 151 (h) x 213 (w) x 6.5 (d) mm
 A4 213 (h) x 300 (w) x 6.5 (d) mm
 A3 300 (h) x 423 (w) x 6.5 (d) mm
 A2 423 (h) x 597 (w) x 6.5 (d) mm
 A1 587 (h) x 844 (w) x 6.5 (d) mm



Very discreet minimal frame →





Linear Vector wall mounted frames are the easy way to create the perfect environment, whether it's a corporate or commercial interior or a retail display where you need to change your message frequently.



Linear Vector Wall Frame

- Aluminium wall mounted graphic frames, available portrait or landscape
- Fitted with lightweight dye sublimated fabric graphics for easy assembly with silicon beaded edges
- Large displays can be created using multiple frames, custom made to order sizes available

Poster size - (h) x (w) mm	Code
A0 - 1189 x 841	VWF-2A0
A1 - 841 x 594	VWF-A1
A2 - 594 x 420	VWF-A2
B0 - 1414 x 1000	VWF-B0
B1 - 1000 x 707	VWF-B1



Linear Vector LED Wall Frame

NEW

Linear Vector wall frame with LED lighting will really catch your customers' attention.

- Aluminium wall frame with textile fabric graphic panel
- Channel to fit silicon edged fabric graphic in to
- LED back lit to all four sides creating atmospheric wall art

High visual impact →

Poster size - (h) x (w) mm	Code
A0 - 1189 x 841	VFAF18-A0
A1 - 841 x 594	VFAF18-A1
A2 - 594 x 420	VFAF18-A2
A3 - 420 x 297	VFAF18-A3
A4 - 297 x 210	VFAF18-A4
B1 - 1000 x 707	VFAF18-B1
B2 - 707 x 500	VFAF18-B2



Trappa Frame

- Simple snap action operation, suitable for substrates up to 0.5mm thick
- Standard Trappa 25mm wide frame in aluminium with anodised silver finish
- Wall mounted, portrait or landscape with mitred corners
- Custom colours and sizes available to order. Standard sizes available from stock

Poster size - (h) x (w) mm	Visible poster area (h) x (w) mm	External frame size (h) x (w) mm	Code
A0 - 1189 x 841	1172 x 824	1220 x 872	AT405-C
A1 - 841 x 594	824 x 577	872 x 625	AT404-C
A2 - 594 x 420	577 x 403	625 x 451	AT403-C
A3 - 420 x 297	403 x 280	451 x 328	AT402-C
A4 - 297 x 210	280 x 193	328 x 241	AT401-C



LED Trappa Frame

NEW

32mm Trappa wall frame with LED back light creates a stylish and visual wall display.

- Snap action frame for easy change graphics
- Available in six sizes from A0 to B1
- LED back lit to all four sides creating exciting pictures

Low power consumption and remains cool to touch →

Poster size (h) x (w) mm	Code
A0 - 1189 x 841	MLAF13-A0
A1 - 841 x 594	MLAF13-A1
A2 - 594 x 420	MLAF13-A2
A3 - 420 x 297	MLAF13-A3
A4 - 297 x 210	MLAF13-A4
B1 - 1000 x 707	MLAF13-B1



Strata cables & stand-offs Signage Systems

The Strata cable and stand-off management system offers a wide variety of wall and ceiling fixings for retail display purposes.



Versatile cable display solutions with a choice of fixing options. Wide range of quality aluminium components for wall or ceiling suspension, available in silver satin finish for a stylish look.

Strata Lite Stand-offs NEW

SP-S01201/1202/1901/1902

- Suitable for 2mm (min) to 10mm thick (max) substrates
- Choice of two diameters: 19mm and 12mm
- Quality aluminium components

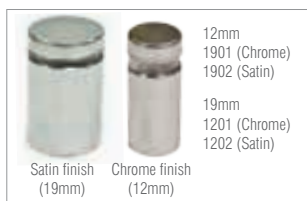

Stand-offs

P0101/102/104/105/117/118

Suitable for 2mm (min) to 10mm thick (max) substrates depending on diameter used

- 16mm dia. Stand-offs are suitable for substrates between 2 to 8mm thick/25mm dia. Stand-offs are suitable for substrates between 5 to 20mm thick
- Choice of rail or screw fix options



Compact variable wall plate

P0106

- 16mm dia. x 25mm, 180° variable fixing
- 360° free moving or lockable
- Suitable for fixing to walls or ceilings



Adjustable fixing cable

P0109

- 4m x 1.5mm Strata adjustable cable kit
- Supplied with rail fixings
- Can be fixed wall to wall, floor to ceiling, direct to wall - extra components required



Double panel support

Code P0122 and P0121

- Suitable for 4mm and 7mm thick substrates:
- 4mm - 10mm dia. x 20mm
- 7mm - 16mm dia. x 43mm with rotating feature for multi-angle fixing

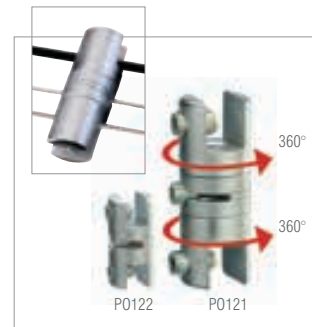

Acrylic poster holders

AH411-415

- Acrylic poster holders have wings to take panel support fixings.
- Can be positioned landscape or portrait
- Available in five sizes from A1 to A5

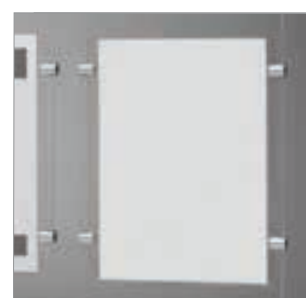

Multi-angle fixing

Rail fix P0114-R / Screw fix P0114-S

- 16mm dia. x 30mm
- Suitable for substrates up to 7mm thick
- Available in rail or screw fixing options





Compact variable cable fixing
 P0107 (rail fixing) / P0108 (screw fixing)

- 16mm dia. x 25mm, 180° variable fixing
- Choice of rail fix or screw fix options
- Cannot be used with P0110 cable kit



Shelf Support
 P0111

- Suitable for shelf substrates 3mm thick min
- 16mm dia x 8mm
- Requires a 9mm dia. aperture in the substrate



Insert rail fixing
 P0115

- Suitable for P0109 Strata Cable Kits and Stand-off components



Panel supports
 P0113/P0112

- Suitable for 4mm and 7mm thick substrates:
- 4mm - 10mm dia. x 15.5mm
- 7mm - 16mm dia. x 20.5mm



Rotating edge stand-offs
 P0119/P0120

- Edge stand-offs eliminate the need for an aperture in the substrate
- Suitable for 2mm (min) to 10mm thick (max) substrates in rail or screw options
- Choice of two sizes: 34mm x 16mm diameter and 34mm x 25mm diameter with distance from wall or ceiling 18.5mm approx

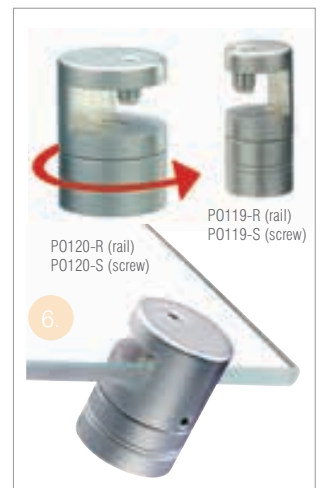

Aluminium rail screw fixing
 PR102

- Fix to Ceiling or Walls – cable fixings slot in and screw in to place
- Available to purchase by the meter
- Complete with moulded end caps



Floor to ceiling fixing cable
 P0110

- 4m x 1.5mm Strata adjustable cable kit
- Supplied with screw
- Not suitable for compact variable fixings



Insert for screw fixing
 P0116

- Suitable for P0109 Strata Cable Kits and Stand-off components



Cable & banner poster rail
 P0206/P0210

- Kit includes 2 x 4m cables and 1 pair of poles
- Available in 600 or 1000mm widths
- Suitable for a variety of looped graphics

Cable kits can also be fitted to Linear frames



Banner poster rails



Trappa Rail

- Simple 'snap-action' rail in aluminium with anodised silver finish
- Can be wall or ceiling mounted and suitable for substrates up to 300 microns thick
- Rails are sold in pairs complete with black or grey end caps and moulded hooks in a wide range of sizes

Rail profile 13mm (h) x 25mm (w)

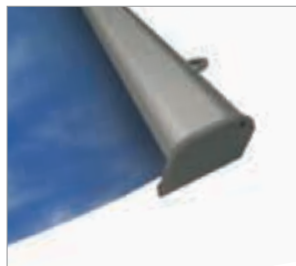

Poster size	Code	Rail size	Code
A0	VH310	1.2m	VH306
A1	VH311	1.0m	VH305
A2	VH312	0.9m	VH304
A3	VH313	0.6m	VH303
A4	VH314	0.5m	VH302
-	-	0.3m	VH301

Twista Lite Poster Rail

NEW

Very cost effective

TWLHR-500/600/800/850/900/1000/1200/1500

- Easy to use 'snap action' poster rail
- Smart modern design that can be wall or ceiling mounted, with aluminium rail and grey plastic end caps and hooks
- For use with a range of media including, paper, card, PVC and fabric up to 300 microns
- Custom sizes available on request



Tex Rail

NEW

- Hanging rail suitable for textile graphics
- Slider rail
- Cost effective and simple to use



Limpit

SP-LIM

- Promoter unit with suction cup system for use on smooth surfaces, car roofs or glass
- Easy to use and reposition with suction cup system
- Accepts material up to 10mm thick

Visible graphic area (approx):
Variable

Total hardware dimensions (approx):
Suction cup 120mm dia.



Trojan

SP-TRO

- Free-standing portable and linkable information unit
- Hollow base can be weighted with water or sand
- Supplied flat pack in three plastic pieces

Visible graphic area (approx):
380 (h) x 330 (w) mm

Total hardware dimensions (approx):
1200 (h) X 380 (w) mm

Linkable posts



Linking chain:
SP-TRO-LC





TABLET HOLDERS, GRAPHIC PODS AND LIGHTBOXES

Visual, Vibrant, Informative

Display audio visual information using a range of tablet holders from counter, flush mounted, free-standing and 360 versions.

Create and impact with either a graphic light box or pod. Illuminate your graphic with LED lighting or use the pod as a visual counter or wall mounted graphic.

Tablet Holders

Choose from a range of stylish iPad holders including free-standing, flush desk mounted, or Zeus case mounted. Each type can support all variations of iPads apart from mini.



Flush mounted table top iPad holder

IPDM/W/S/B

NEW

- Suitable for use on a variety of table tops and counter units and available in black, white or silver surrounds
- Minimum area in which the holder can fit is 450mm dia.
- Price of unit includes housing and components pre-fitted into relevant counter top of your choice

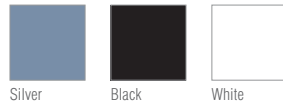

*Table top counter and iPad not included in price

Total hardware dimensions (approx):
Size depends on table top requested

Zeus table top with iPad holder

CO401-IPW/IPB/IPS

AR+

- Designed to fit into the recessed area on the lid of the Zeus case, secured with strong hook and loop fastenings
- Table top available in walnut, white, black or silver thermoform
- Price includes table top with housing fitted and supplied in box



Total hardware dimensions (approx):
Table Top: 25 (h) x 420 (w) x 640 (l) mm

*Zeus case and iPad not included

Spiral Plinth table top with iPad holder

UB710-IPDM-W/B/S

- Secure flush mounted iPad holder for the Spiral display system
- Available as a table top unit in silver, black or white surround
- Thermoformed table top available in walnut, white, black, silver, walnut or birch



*Spiral Plinth sold separately and iPad not included

Total hardware dimensions (approx):
Table top: Height: 25 (h) x 580 (w) x 580 (l) mm

iPad holder 360°

IPAD-360B/S/W

NEW

- Tilt and rotate your iPad 360°
- Can be mounted onto desk top, wall or Linear post
- Comes complete with all parts and fixing kit
- Available in black, silver and white surround



Free-standing iPad holder

IPS-001-B/S/W

NEW

- Secure housing with security screws and allen key
- Can be positioned portrait or landscape
- Available in black, silver or white and is durable and theft resistant



Total hardware dimensions (approx):
Landscape: 1045 (h) x 360 (base dia.) mm
Portrait 1060 (h) x 360 (base dia.) mm

AR+

Standard Linear Column

Frame only - LNC-STF0/ Lightbox - LNC-STLB
Optional iPad holder 360° - IPAD-360B/S/W

NEW

- Standard sized counter with option to have printed graphic panels
- Optional iPad holder 360° for multi media solutions
- Lightbox version comes with white panels, optional printing available
- Internal LED lighting options of white or RGB



Visible graphic area (approx):
970 (h) x 525 (w) mm graphic panel

Total hardware dimensions (approx):
1010 (h) x 640 (w) x 325 (d) mm

iPads not included

Slim Linear Column with optional iPad holder 360° is a neat and streamlined pod with the added benefit of a multi-angled iPad holder for when extra visual information is required.

Slim Linear Column
 Frame only - LNC-SLFO / Lightbox - LNC-SLLB
 Optional iPad holder 360° - IPAD-360B/S/W

- Slim sized counter with option to have graphic panel front and back
- Made from aluminium posts with a choice of five MDF table top colours
- Lightbox option available which comes with panels front and back and internal LED lighting options of white or RGB
- Can support the iPad holder 360°

Visible graphic area (approx):
 970 (h) x 280 (w) mm graphic panel

Total hardware dimensions (approx):
 1010 (h) x 380 (w) x 245 (d) mm



Lightbox option

iPads not included



Optional iPad holder 360°



Reflecta Trappa Graphic Pod or Lightbox

NEW

Available as lightbox or graphic pod

- Free-standing double sided lightbox or graphic pod, with elegant looks and ease of assembly it is ideal for retail display applications
- Available with Trappa style posts with easy to use 'snap action' aluminium rails to support range of media types, and can support Linear accessories
- Top and base available in a choice of walnut, silver, black, white or birch



Total hardware dimensions (approx):

Lightbox code	Pod code	Size (mm)
MR912T**	MR102T**	1840 (h) x 1000 (w) x 400 (d)
MR911T**	MR101T**	1040 (h) x 1000 (w) x 400 (d)
MR915T*	MR104T*	1570 (h) x 570 (w) x 280 (d)
MR914T*	MR103T*	840 (h) x 570 (w) x 280 (d)

* Supplied with opal hips and acetate
** Supplied frame only

Reflecta D

ML901/2/3

- High visibility D-shaped wall mounted lightbox
- Available in A1, A2, A3 in landscape or portrait and can support substrate up to 200 micron
- Snap frame with TFL cool fluorescent tube, mains lead and plug

Brightens up any wall



Total hardware dimensions (approx):

Code	Size (mm)
ML901	A1 - 847 (h) x 580 (w) x 130 (d)
ML902	A2 - 600 (h) x 410 (w) x 110 (d)
ML903	A3 - 420 (h) x 290 (w) x 95 (d)



ACCESSORIES

Enhance, Improve, Complement

Don't forget to light up your display with our impressive range of lighting solutions.

We have a bag or case for just about any product, why not transform your case into a portable counter offering multiple options from just one product.



The Oyster case is a spacious sturdy 'clam style' transportation case which converts quickly into a stylish and surprisingly XL sized counter.

Oyster case

AC507-C case / G-OYS-PV with wrap

- Large wrap around table top and integral locking nuts to secure quickly into place
- Two detachable shelves for storage
- Design your own graphics on the wrap
- Store your pop-up display, plus table top and shelves inside Oyster and wheel away

Visible graphic area (approx):
 920 (h) x 1745 (w) mm

Total hardware dimensions (approx):
 Open: 1020 (h) x 1430 (w) x 595 (d) mm
 Closed: 1010 (h) x 660 (w) x 430 (d) mm



The Oyster case transforms into a counter with two detachable shelves



Carry handle for easy transportation

Ellipse Plus

AC337 case / C0337-C with table top
AC337-002 - Full fabric wrap

- Manufactured from tough moulded polyethylene (MDPE) that can carry one 3x4 curved or straight pop-up frame with graphic panels and mag bars
- Wheels and handle for easy transportation and removable internal divider to protect graphics
- Optional folding table top and graphic wrap to convert case into a counter, table top supplied in birch as standard but other thermoformed finishes are available on request

Visible graphic area (approx):
790 (h) x 1610 (w) mm

Total hardware dimensions (approx):
950 (h) x 395 (w) x 595 (d) mm



Unique built-in four pocket leaflet dispenser



Table top as optional extra

Zeus Case

AC338 case / C0203Z Fabric wrap
C0401-C - Table-top



- Wheeled lockable pop-up case designed for safe transportation of pop-up frame, fixings and graphics, manufactured from tough moulded polyethylene (MDPE).
- Will accept one 3x5 curved or straight pop-up frame with graphic panels and mag bars, internal divider to protect graphics included
- Optional folding table top and graphic wrap to convert case into a counter, table top supplied in birch as standard but other thermoformed finishes are available on request

Visible graphic area (approx):
785 (h) x 1775 (w) mm

Total hardware dimensions (approx):
990 (h) x 640 (w) x 410 (w) mm

*Optional iPad table top holder also available, see page 89 for full details



Leonardo

AC340

- A strong and durable, wheeled pop-up case with wheels and handle for safe transportation of graphics
- Manufactured from tough moulded polyethylene (MDPE), you can join two cases together to create an oval counter
- Optional fabric wrap and tabletop to convert the case into a counter available in birch, black, walnut, silver or white thermoformed finishes

Visible graphic area (approx):
702 (h) x 1270 (w) mm

Total hardware dimensions (approx):
Internal: 850 (h) x 355 (w) x 280 (d) mm



Two cases can be joined together

Wheeled moulded Linear case

AC506

- Large, wheeled carry case for transporting linear extrusion and kits
- Stackable for easy storage, complete with support straps for extra security
- Optional three tier inserts configurable to store different linear extrusions

Total hardware dimensions (approx):
1300 (h) x 740 (w) x 360 (d) mm



Cases and Bags Accessories

Carry and store all your graphics and hardware safely with a large choice of bags and cases to work across our product range. Transform a selection of cases into counters with graphic wraps and table tops.



Stealth case

Case: AC433 / Case wrap: C0333Z /

Table top: C0332

- A versatile and adaptable case to house components and graphics for the Stealth banner system
- Separate compartments to securely hold two Stealth units with graphics and lights
- Optional folding table top to create a counter
- Optional fabric wrap to personalise your counter

Visible graphic area (approx):
800 (h) x 1600 (w) mm

Total hardware dimensions (approx):
970 (h) x 520 (w) x 440 (d) mm



Transport case, available options include case wrap and folding table top



Suitable for storing two Stealth units, a flexible joining panel and case wrap graphic.

Graphic case 1200

AC332

- Manufactured from tough moulded polyethylene and enables you to transport display graphics up to 1200mm wide
- Holds up to eight graphic drops, ideal for rolled banners and pop-up graphics
- Complete with handle and wheels for easy use

Visible graphic area (approx):
1065 (h) x 1585 (w) mm

Total hardware dimensions (approx):
1250 (h) x 520 (w) x 440 (d) mm



Graphic case 900

AC333

- Manufactured from tough moulded polyethylene that enables you to transport display graphics up to 900mm wide
- Holds up to eight graphic drops, ideal for rolled banners and pop-up graphics
- With handle and wheels for easy use

Visible graphic area (approx):
795 (h) x 1585 (w) mm

Total hardware dimensions (approx):
970 (h) x 520 (w) x 440 (d) mm



Pop-Up drum

AC304

- Economical wheeled pop-up drum case with handles and wheels for safe transportation of pop-up and graphics.
- Foam lined base for added protection
- Suitable for up to a 3 x 4 curved or straight pop-up with graphics
- Will also carry a maximum of 10 regular height pop-up graphic panels (no frame)

Total hardware dimensions (approx):
860 (h) x 440 (w) x 390 (d) mm



Graphic drums

AC305/306/365/366

Choose from a range of sizes to enable you to transport graphics safely and securely
Manufactured from tough yet lightweight polyethylene

Total hardware dimensions (approx):
AC305 - 850 (h) x 400 (dia.) mm
AC306 - 850 (h) x 300 (dia.) mm
AC365 - 1020 (h) x 400 (dia.) mm
AC366 - 1020 (h) x 300 (dia.) mm



Polypropylene cases

- Range of cost effective cases to store and transport graphics, panels, pop-ups, and literature stands
- Standard sizes or custom made using strong polypropylene material
- Optional extras on some cases include wheels and extra padding



Carry bags

- Large range of bags to carry and store panel systems, banners, portable furniture and literature racks
- Standard sizes of bags or custom made to order
- Optional extras on bags include wheels and extra padding



Graphic banner tube

AB120

- Lightweight fabric bag with a choice of cardboard tubes
- Ideal for transporting tension banners or rolled graphics
- Choice of four heights, 850, 1050, 1250 or 1550mm, available with or without inner tube



Pop-up frame fabric bag

AB105

- Lightweight protective carry bag
- Takes up to 4x3 frame size
- Carry handle on top of bag



Base bag

AB108

- Lightweight fabric bag
- Can hold up to four 300mm dia bases
- Complete with carry handles

Total hardware dimensions (approx):
320 (h) x 320 (w) x 60 (d) mm



Padded lighting bag

AB101

- Suitable for transporting two PS1000 halogen lights
- Complete with carry handles and zip

Total hardware dimensions (approx):
570 (h) x 180 (w) x 120 (d) mm



Mag bar bag

AB104

- Keeps your pop-up mag bars safe and clean
- Capacity to house up to 21 mag bars
- Complete with carry handle

Total hardware dimensions (approx):
735 (h) x 110 (w) x 70 (d) mm



Adjustable graphics tube

GBT-001

- Lightweight graphics drum with shoulder strap for easy transportation
- Telescopic body adjusts to fit a range of graphic sizes
- Manufactured from lightweight polypropylene with a twist and lock lid, ideal for banner graphics

Total hardware dimensions (approx):
Telescopic body, extendable from 770 (h) to a maximum of 1250 (h) mm



Flush mounted table top iPad holder

IPDM/W/S/B

NEW

Available to use on a wide variety of table tops

- Suitable for use on a variety of table tops and counter units and available in black, white or silver
- Minimum area in which the holder can fit is 450mm dia.
- Price of unit includes housing and components pre-fitted into relevant counter top

Table top, counter and iPad not included in price

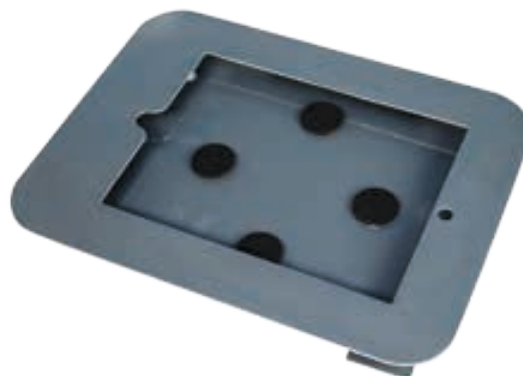

Lighting Accessories

Enhance your stand or banner with atmospheric lighting.
Choose from a wide range of options.



Powerspot 50

PS050

- 240v 60 watt mains spotlight for use with panel systems
- 3m power lead with UK or Euro plug, replacement lamps available
- Available in silver with clamp fixing



Powerspot 250*

PS250

- 50 watt spotlight in silver, includes 240v transformer
- Telescopic arm and 3m lead with UK or Euro plug fitting
- Supplied individually or as two or four light kits, which include lights, a carry case and a four way extension cable



Powerspot 750*

PS750

- 50 watt spotlight with adjustable head, silver with universal fitting for panels, pop-ups and Arena4 Gantry.
- 3m power lead with UK or Euro plug, includes 240v transformer
- Two or four light kits include lights, a carry case and a four way extension cable



Powerspot 800*

PS800

- 50 watt mains floodlight offering 5500k warm white glow
- Low power consumption with 20,000 hours of use approx
- Anodise silver finish with integral bulldog clip specifically designed for banner stand poles



Powerspot 950

PS950

- 150 watt mains floodlight offering 5500k warm white glow
- Low power consumption with 20,000 hours of use approx
- Anodise silver finish
- Pop-up only, not suitable for Pop-up Tower



Powerspot 1000*

PS1000

- 150watt mains halogen floodlight for use with pop-up systems and linear systems.*
- Available in black or silver, lamp is protected by a glass barrier for safety
- 250mm straight arm with adjustable head, universal fitting and 3m power lead with UK or Euro plug



Powerspot 1060 LED Floodlight*

PS1060S

- 20 watt mains floodlight offering 5500k warm white glow
- Low power consumption with 20,000 hours of use approx
- Anodise silver finish with universal fitting for panels, pop-up and Linear



*Linear systems require additional fitting (US-LINEAR)

Powerspot 1200

PS1200

- 20 watt fluorescent light suitable for illuminating pop-up end panels or for back lighting balloon panels
- Simply clip on to attach, Ultra slim design
- Up to six lights may be linked together using optional connecting lead US601B



LED Lighting

- Wide range of LED light options available.



Universal Fitting Kit

US901-C



*On ordering please specify application as specific fittings may be required.

Custom capabilities guide

There are many items in the range that can be customised or made-to-order, providing an unrivalled level of flexibility. These include:

Linear and Linear Vector modular aluminium frame systems - you can use 'elements' to configure your own display design or we can work from a custom brief.

Banner stands - Original 2 and 3 can be manufactured to custom widths.

Pop-ups - can be built to custom configurations based on standard 'quads' as building blocks.

Fabric panels for banners and pop-ups - simply select your fabric and place your order.

Physique portable counters - manufactured to custom designs and sizes with a range of finishes to choose from for the side panels, tops and bases. You can even have custom logos engraved, thermoformed into wooden tops and UV printed.

Carry bags - canvas bags can be manufactured to custom specifications.

Panel kits - standard panels in custom configurations.

Panel & Pole - standard panels in custom configurations and custom sized panels.

Poster frames and rails - manufactured to custom sizes.

Promoter units and lightboxes - manufactured to custom sizes.

Fabric options guide

Standard Loop Nylon



Luxury Foam Backed Nylon

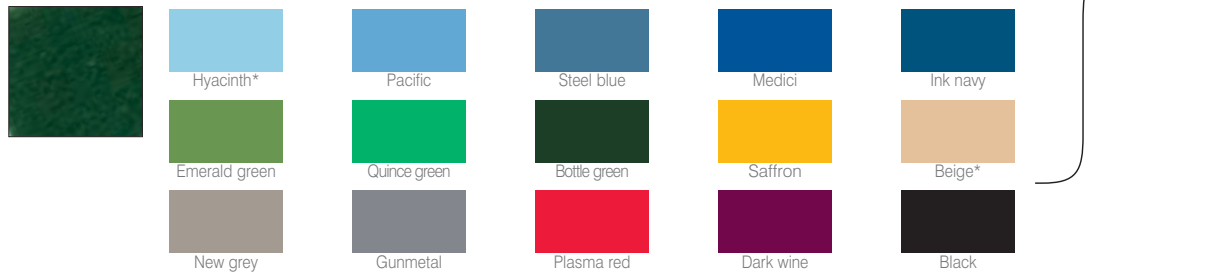

Smooth (formerly Prelude)

Phantom Panels and Portable Furniture Wraps

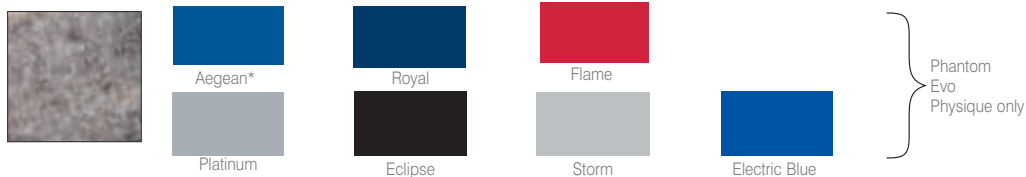

All colours are only given as a guide - for a more exact match, samples are available on request.

*While stock lasts

Table top and shelf covering options

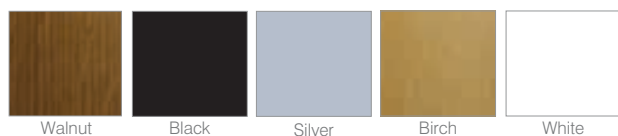

Other colours can be ordered on request subject to availability.

Optional UV printing and engraving on any table top





IMAGE DISPLAY

SIGNS - PRINTING - EXHIBITION DISPLAYS - PROMO ITEMS

www.imagedisplay.co.uk - www.boombranding.co.uk

sales@imagedisplay.co.uk

Our product range

We are dedicated to delivering the widest choice of products from cost effective to premium quality. We promise to continuously search for new and pioneering ideas bringing innovation and excitement to our complete range of portable display products.

Our products cover a broad range of needs from simple cost effective display solutions to more comprehensive and specialist displays for both one off and semi-permanent use.

Guarantee

ONE
YEAR

FIVE
YEAR

LIFE
TIME

All products are covered by a manufacturer's guarantee against component failure and defects. Our premium banner range is covered by a lifetime guarantee, the rest of our range is covered by a five year guarantee with the exception of our illuminated, Basics and Outdoor products which are covered by a one year guarantee.

We are continually improving and modifying our product range and reserve the right to remove products or vary the specifications without prior notice. All dimensions state height first. All dimensions, graphic information and any weights quoted are approximate and should be used as a guide only.

We accept no responsibility for variance. E&OE

DISPLAY SOLUTIONS HANDBOOK

Design and Patent

Some of the products in our catalogue carry a worldwide Patent, some carry a Design Patent. All of our unique products are designed in the UK / USA and designs are registered.

Due to variations in graphic substrates, graphic thicknesses stated are provided as a guide only. Always check the suitability of your substrate on the display unit before application.